

# **B** BASSO *alumínios*

**CATÁLOGO DE PRODUTOS 2024**



## QUALIDADE QUE FAZ A DIFERENÇA!



### BASSO ALUMÍNIOS

Com 6 anos de história no mercado gaúcho, a Basso Alumínios surgiu em Passo Fundo com o propósito de atender a demanda de perfis de alumínio e componentes para os mais diversos segmentos. Hoje contamos ainda com uma filial em Ijuí, no Noroeste do Rio Grande do Sul e outra filial em Passo Fundo para atendimento express.

### NOSSOS PRODUTOS

Trabalhamos com produtos nacionais e importados das marcas mais renomadas do setor, tais como: perfis e componentes para esquadrias de alumínio, perfis e ferragens para vidro temperado, perfis para linha moveleira, chapas de policarbonato, entre outros.

Com frota própria e entregas semanais, temos como objetivo atender com excelência as necessidades dos nossos clientes.

### MATRIZ

-  54 3315.8900
-  54 9 9662.5905
-  vendas@bassoaluminios.com.br
-  bassoaluminios.com.br
-  Rua Dionísio Lângaro, 203  
Bairro Lot. Leonardo Ilha - 99.052-327  
Passo Fundo - RS

### FILIAL PASSO FUNDO

 54 3254.0298

### FILIAL IJUÍ

 55 3195.0727

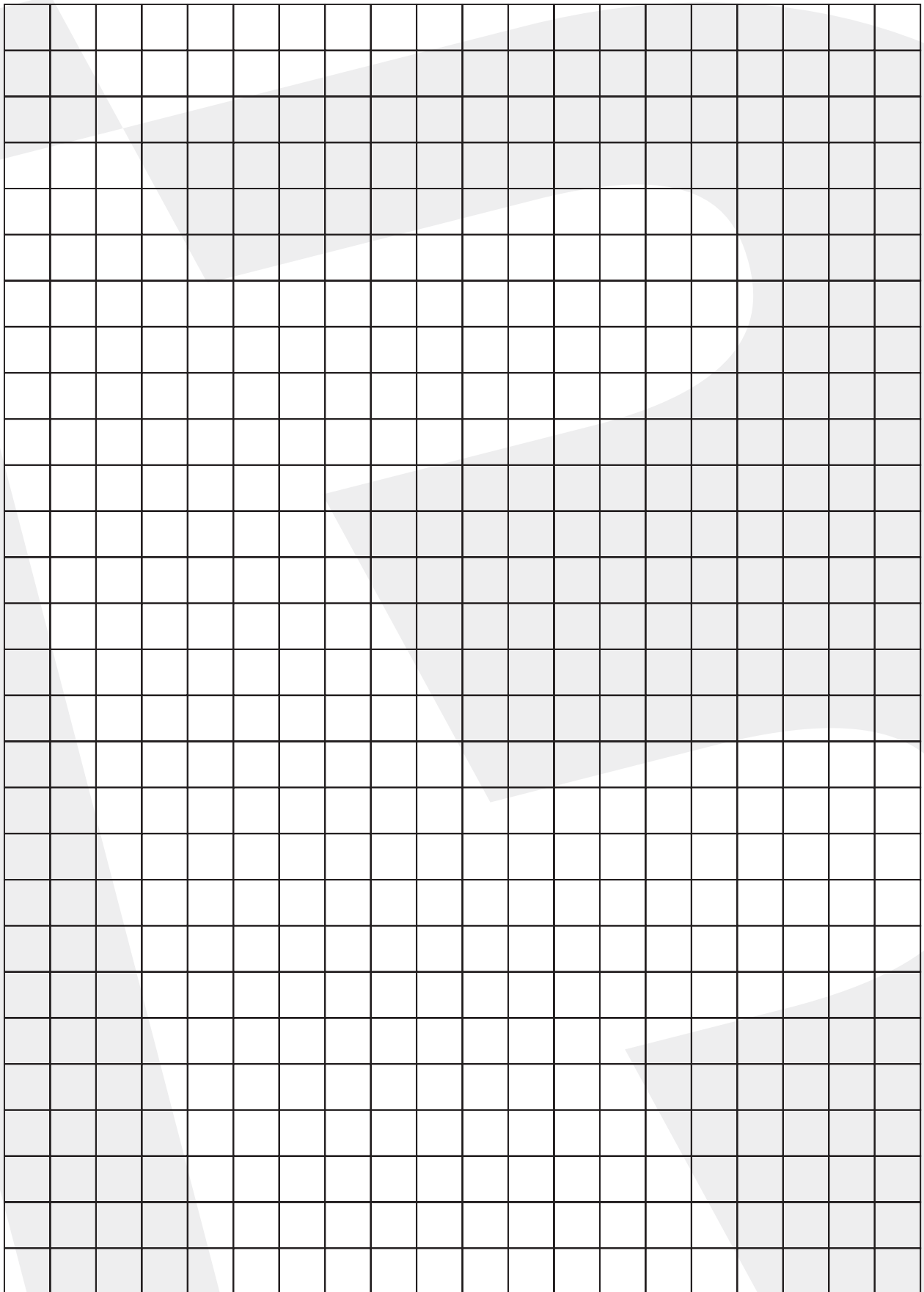

Empresa.....	01
Padronizado.....	05
Linha 25.....	08
Linha 30.....	10
Marco Regulável.....	11
Linha Suprema.....	13
Linha Gold.....	27
Módulo Max.....	38
Módulo Prático.....	39
Portões de Contrapeso.....	43
Lambris / Portões de Correr.....	45
Venezianas.....	48
Arremate.....	49
Linha Contramarco.....	49
Linha Macho e Conexões.....	50
Cunha e Cantoneiras.....	50
Policarbonato.....	50
Linha Diversos.....	51
Linha Gradil Convencional e Panorama.....	52
Linha Pele de Vidro II.....	53
Linha Box / Vidro temperado.....	57
Linha Box.....	59
Linha Sorobox.....	59
Moveleira.....	60
Componentes - Fecho.....	62
Componentes - Roldana.....	63
Componentes - Dobradiça.....	64
Componentes - Max Ar.....	65
Componentes - Persiana.....	66
Componentes - Gold.....	68
Componentes - Nyl.....	71
Componentes - Gradil.....	73
Contramarco e Mosquiteira.....	74
Fechaduras.....	75
Box.....	76
Chapa Acrílico.....	77
Pele de Vidro.....	78
Ferragem VSM.....	79
Kit Box.....	100
Geral.....	101
Guarnições.....	103

## Atenção

Esta é uma tabela de referência para pesos e medidas dos materiais presentes neste impresso. A Basso Alumínios reserva-se o direito de alterar pesos e medidas sem necessidade de aviso prévio. Consulte nossos vendedores ou departamento técnico. Em caso de diferença entre os pesos e/ou medidas aqui presentes, serão válidas as informações atualizadas em nosso sistema.

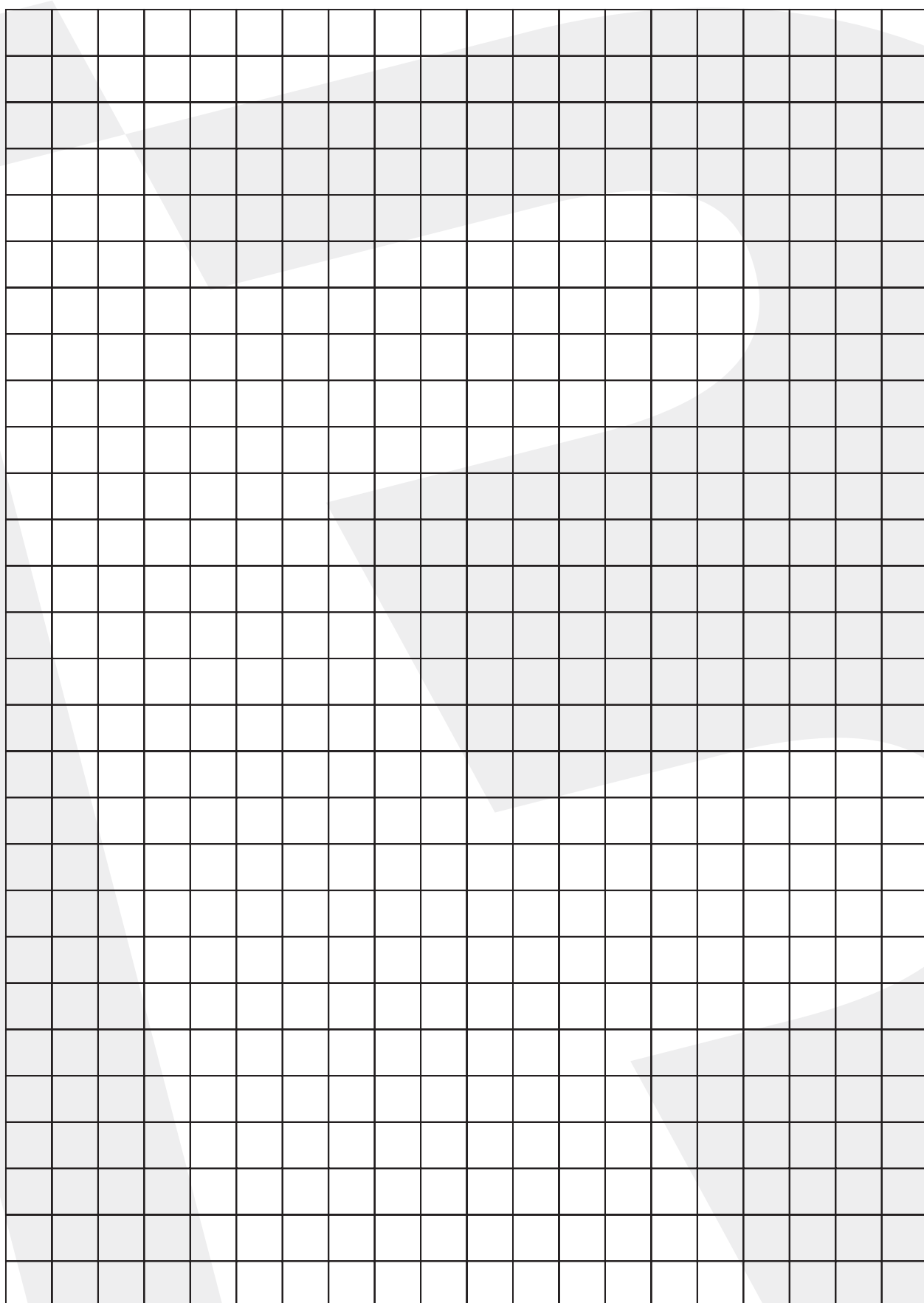

## PERFIL "L" - ABAS IGUAIS

	Peso (kg/m)	Milímetros		Polegadas	
		A	C	A	C
CT-005	0,136	15,87	1,58	5/8"	1/16"
CT-007	0,157	19,05	1,58	3/4"	1/16"
CT-016	0,228	25,40	1,58	1"	1/16"
CT-026	0,633	38,10	3,17	1,1/2"	1/8"

## PERFIL "U" - ABAS IGUAIS

	Peso (kg/m)	Milímetros		Polegadas	
		A	C	A	C
PU-800	0,075	9,50	0,90	-	-
PU-002	0,150	12,70	1,58	1/2"	1/16"
PU-004	0,193	15,87	1,58	5/8"	1/16"

## PERFIL "U" - ABAS DESIGUAIS

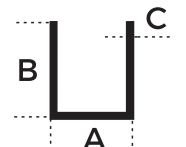
	Peso (kg/m)	Milímetros			Polegadas		
		A	B	C	A	B	C
PU-344	0,217	15,00	25,00	1,30	-	-	-
PU-071	0,393	14,00	48,00	1,60	-	-	-
BX-137	0,166	14,00	22,00	1,10	-	-	-
BX-103	0,133	11,00	22,00	1,10	-	-	-

## TUBO REDONDO

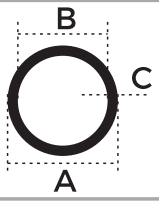
	Peso (kg/m)	Milímetros		Polegadas	
		A	C	A	C
TR-005	0,158	12,70	1,58	1/2"	1/16"
TR-018	0,173	19,05	0,90	3/4"	-
TR-040	0,320	25,40	1,50	1"	-
TR-055	0,405	31,75	1,58	1.1/4"	1.1/6"
TR-070	0,489	38,10	1,58	1.1/2"	1.1/6"
TR-098	0,666	50,80	1,58	2"	1.1/6"
TR-135	1,201	76,20	1,90	3"	-

## TUBO QUADRADO

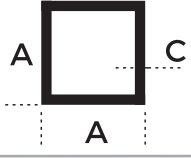
	Peso (kg/m)	Milímetros		Polegadas	
		A	C	A	C
TQ-009L	0,346	25,40	1,00	1"	-
TQ-013L	0,425	38,10	0,90	1.1/2"	-
TQ-017L	0,865	50,80	1,70	2"	1/16"
TQ-080	1,611	80,00	2,30	-	-
TQ-034	2,686	100,00	2,60	-	-

## TUBO RETANGULAR

	Peso (kg/m)	Milímetros			Polegadas		
		A	B	C	A	B	C
TG-002	0,165	25,40	12,70	1,00	1"	1/2"	1/32"
TG-074	0,185	25,40	12,70	-	-	-	-
TG-015	0,333	50,80	12,70	0,90	2"	1/2"	-
TG-001	0,393	50,80	25,40	1,20	2"	1"	1/32"
TG-073	0,408	50,80	25,40	1,00	2"	1"	-
TG-014	0,916	76,20	38,10	1,50	3"	1.1/2"	1/16"
TG-009S	1,316	95,00	50,80	1,80	-	2"	1/16"

## BARRA CHATA

	Peso (kg/m)	Milímetros		Polegadas	
		A	C	A	C
BC-008	0,141	-	-	-	-
BC-009	0,205	15,87	4,76	5/8"	3/16"
BC-016	0,250	19,05	4,76	3/4"	3/16"
BC-025	0,219	25,40	3,17	1"	1/8"
BC-050	0,333	38,10	3,17	1.1/2"	1/8"

## VERGALHÃO

	Peso (kg/m)	Milímetros	Polegadas
		A	A
VR-002	0,360	6,35	1/4"



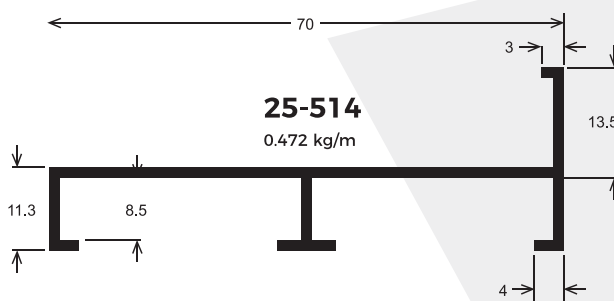
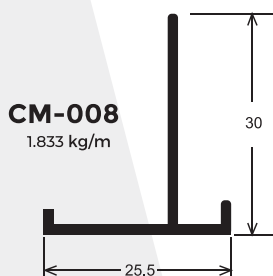
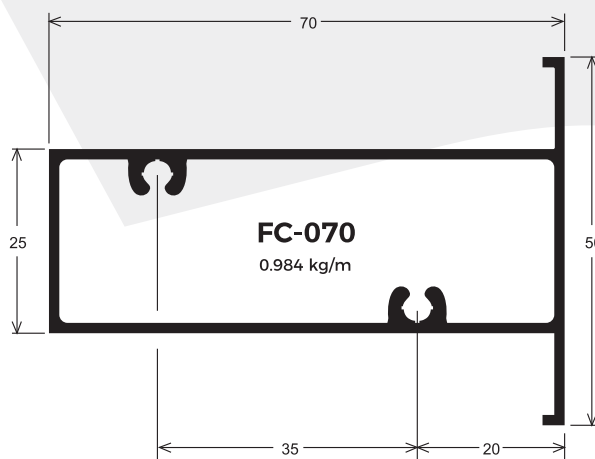
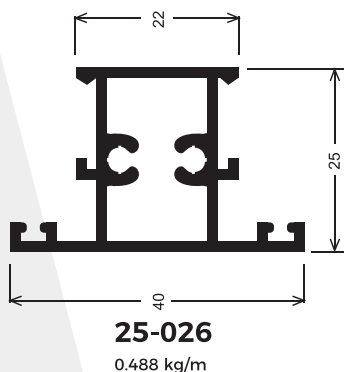
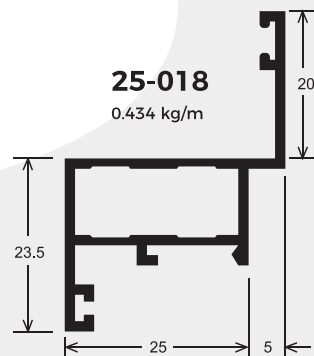
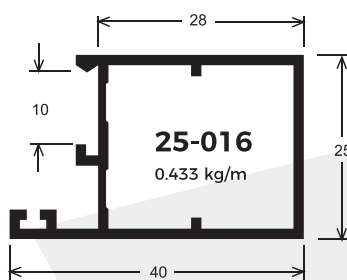
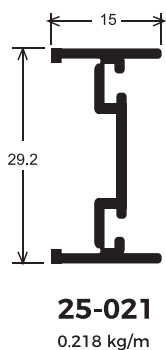
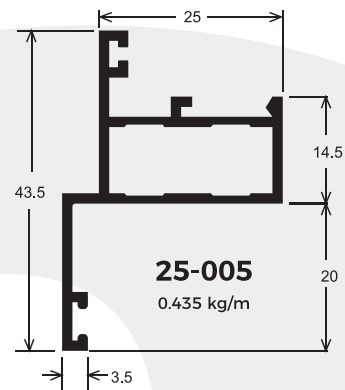
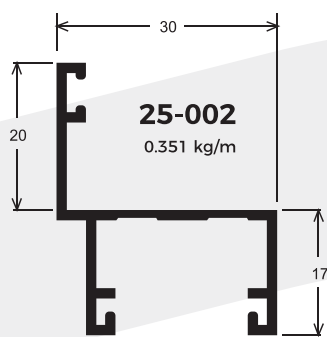
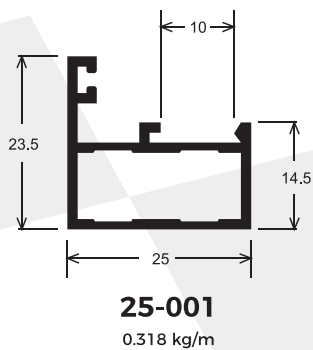

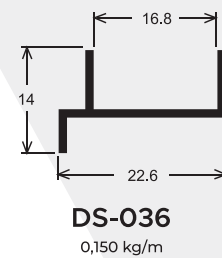
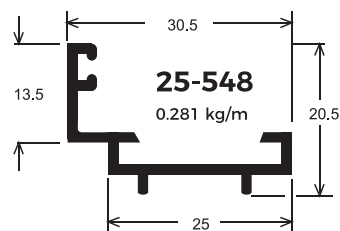
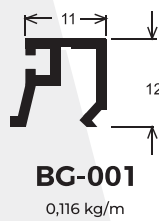
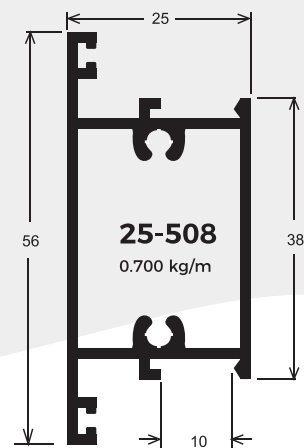
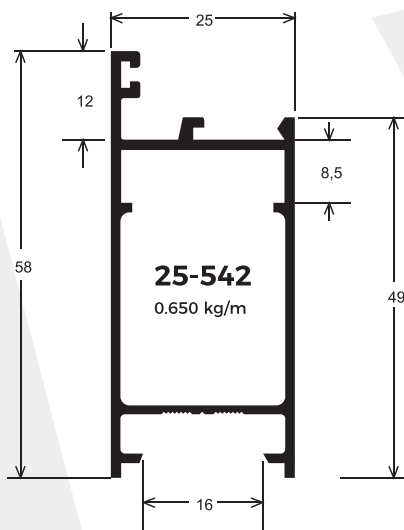
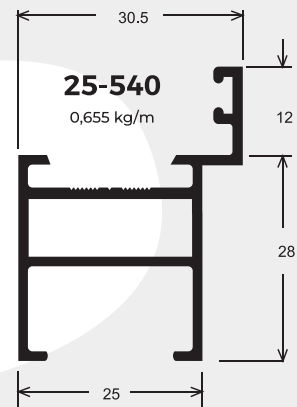
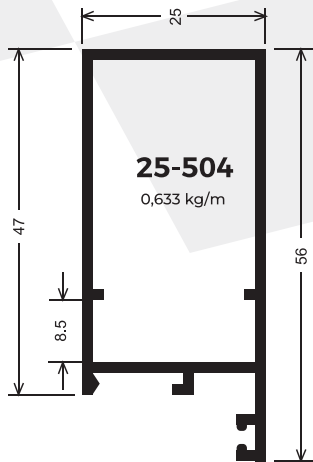

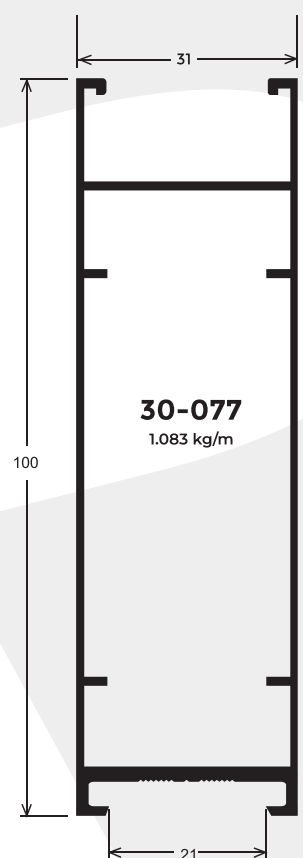
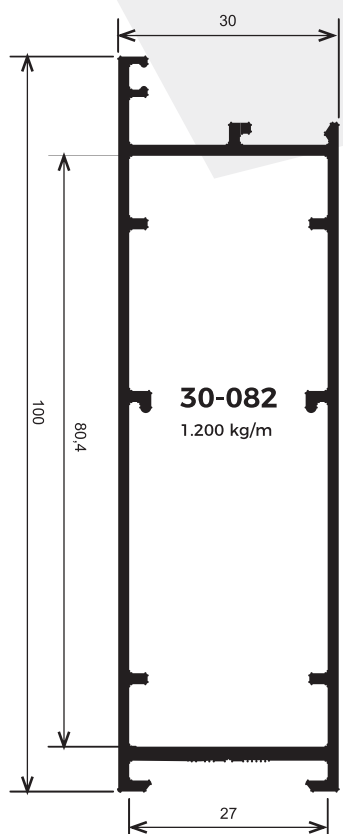
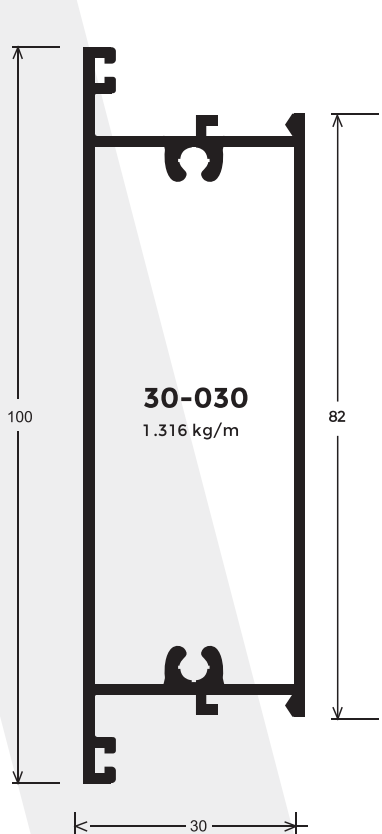
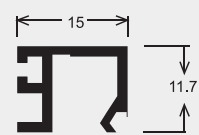
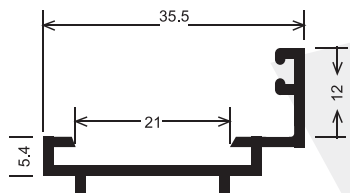
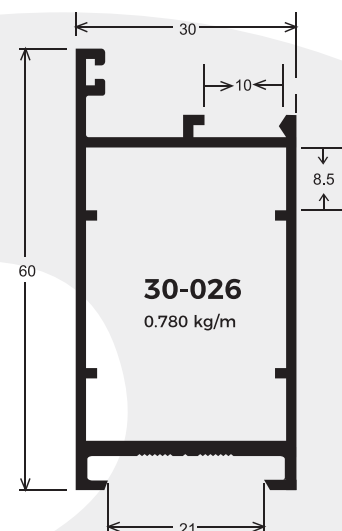
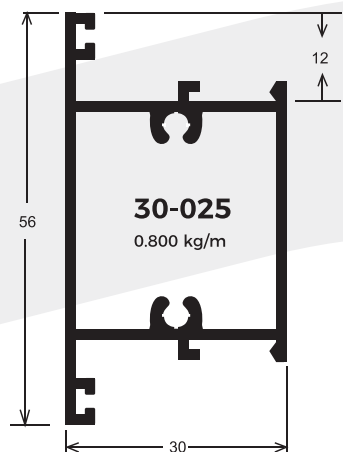
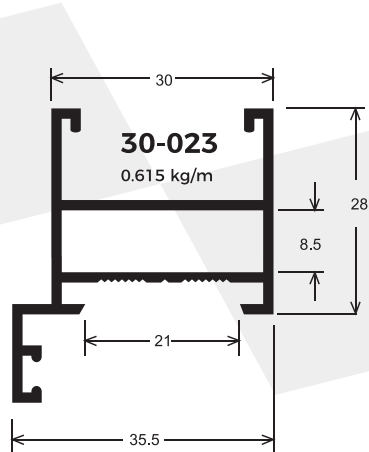

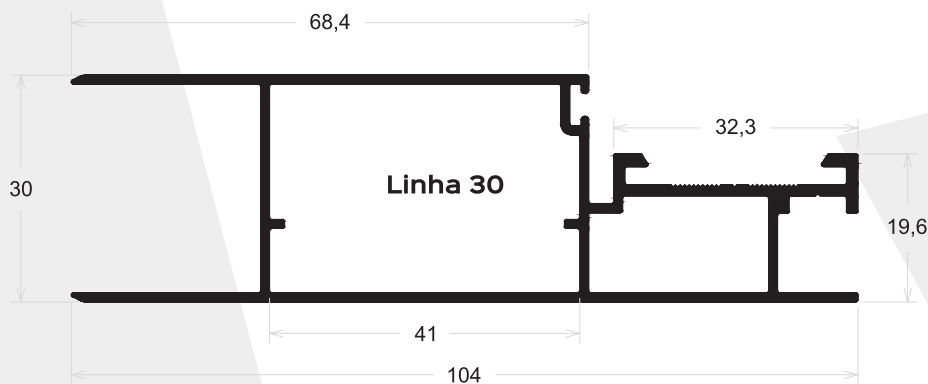
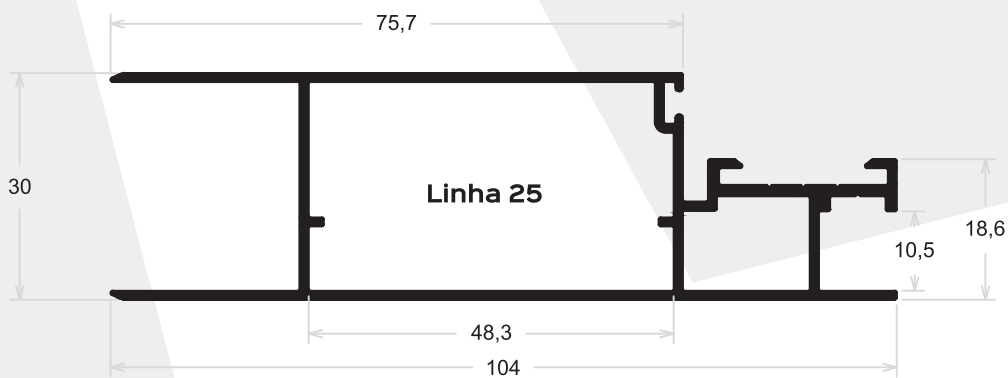
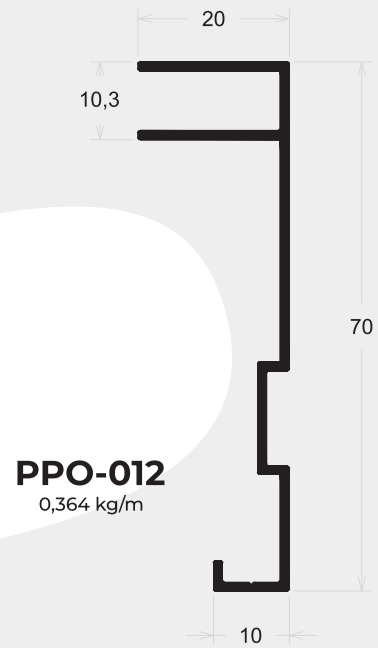
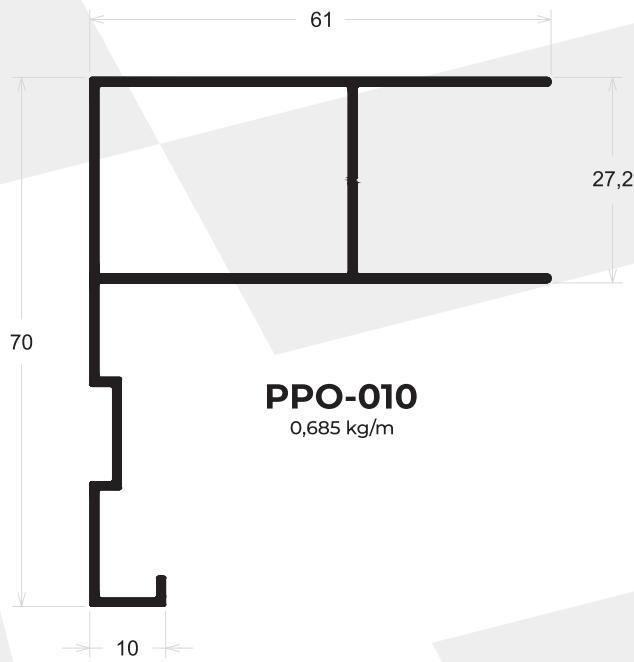

## PPO-007

1,097 kg/m

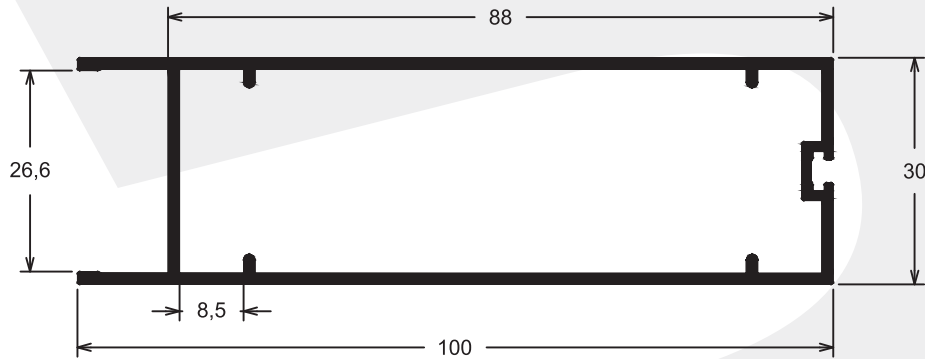

## PPO-011

0,369 kg/m

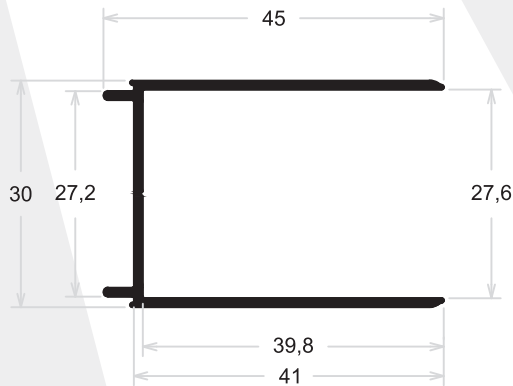

## DV-014

0,343 kg/m

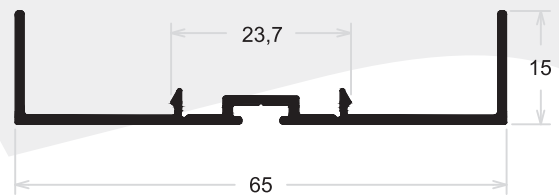

## PPO-014

0,056 kg/m

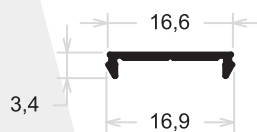

Linha 25

## PPO-013

0,070 kg/m

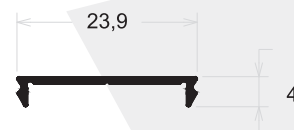

Linha 30

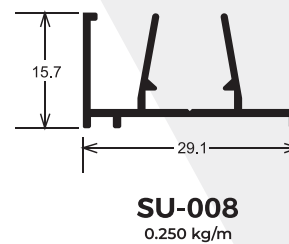
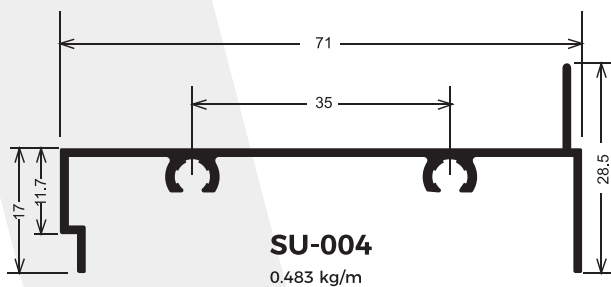
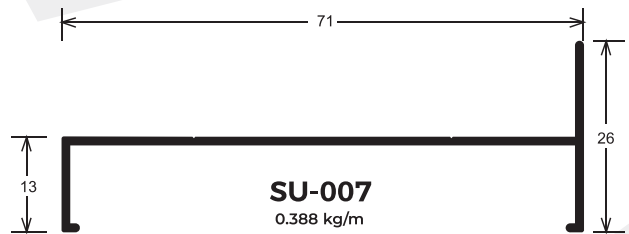
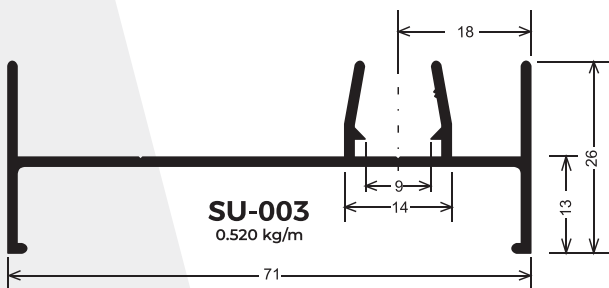
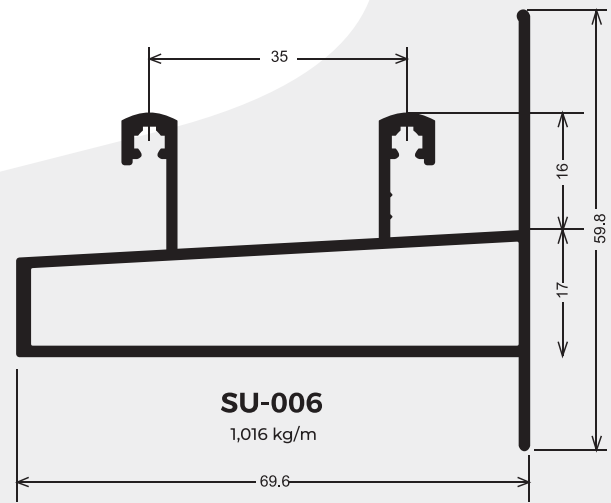
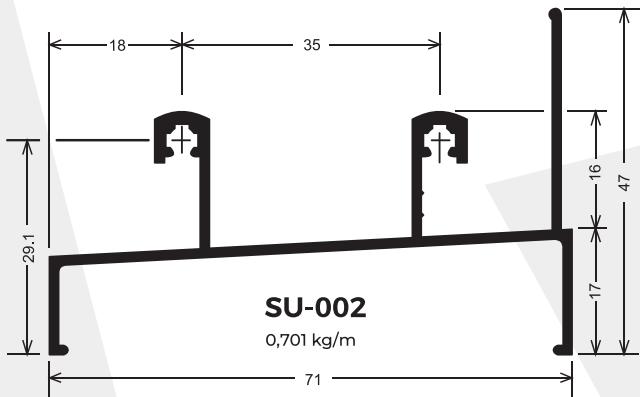
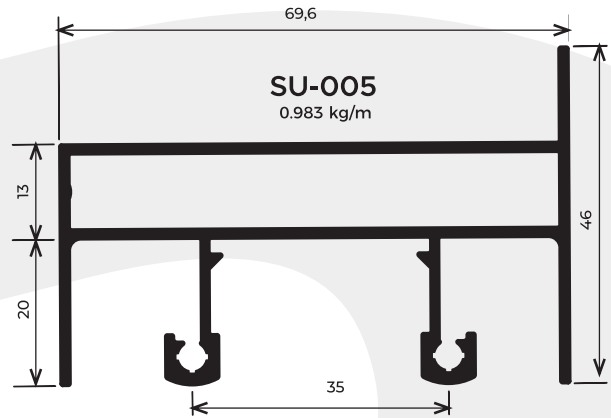
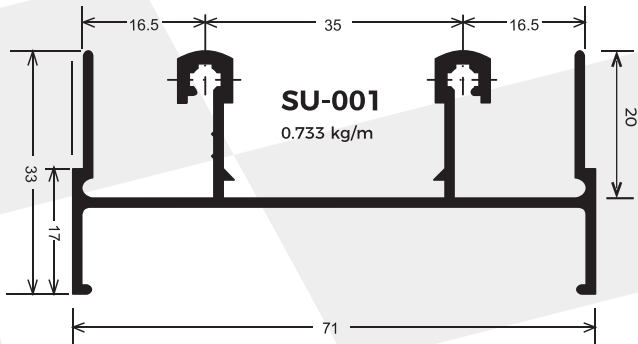

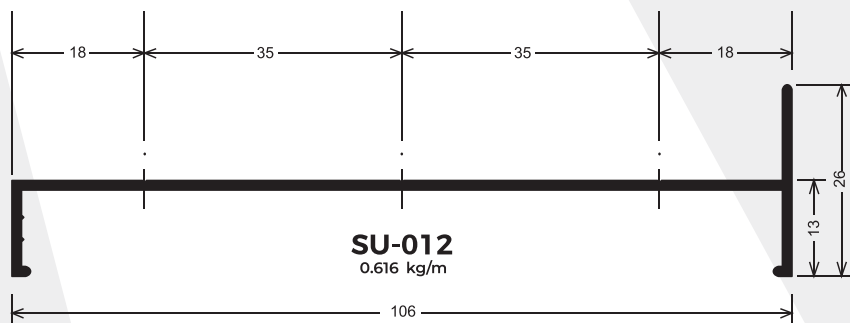
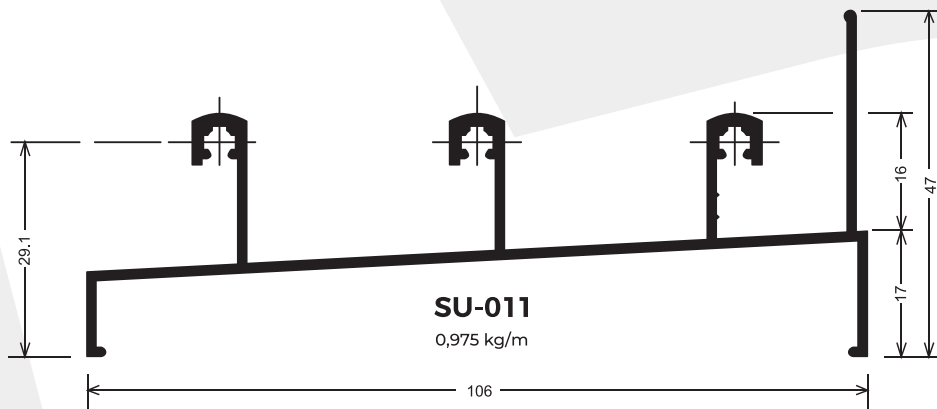
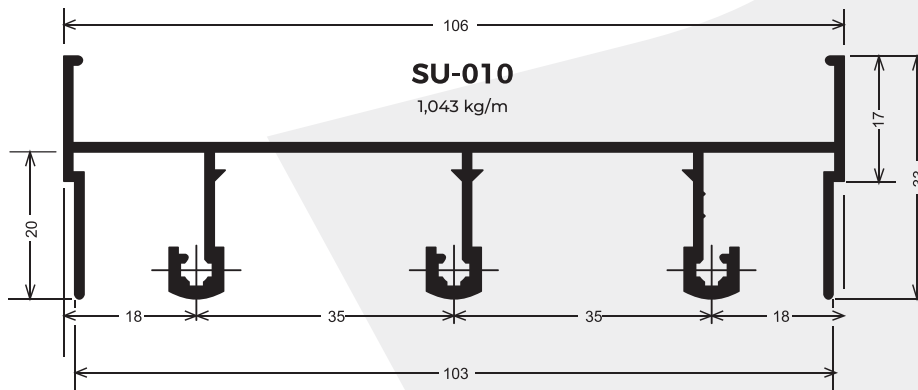
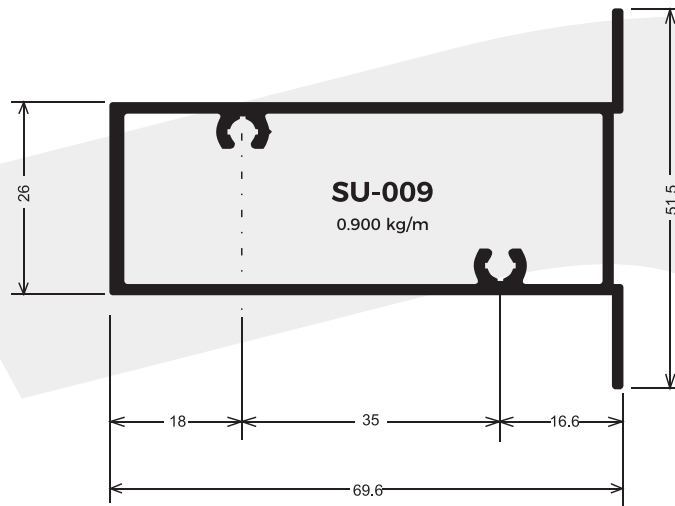

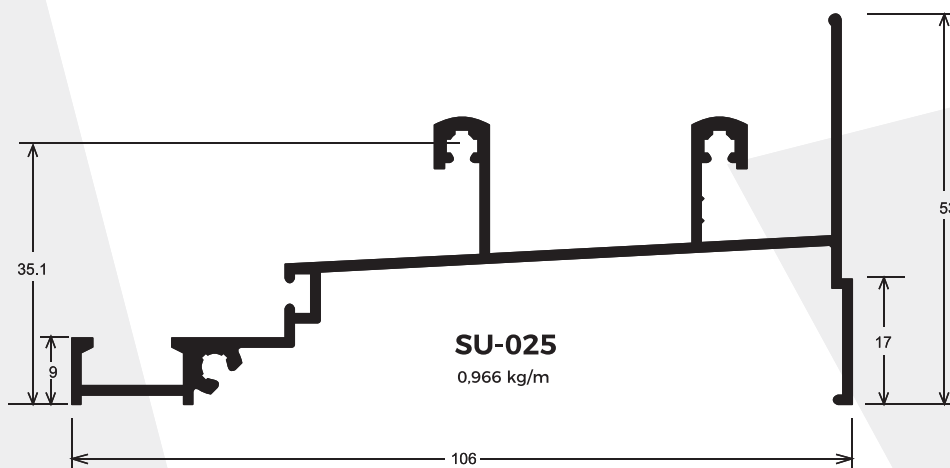
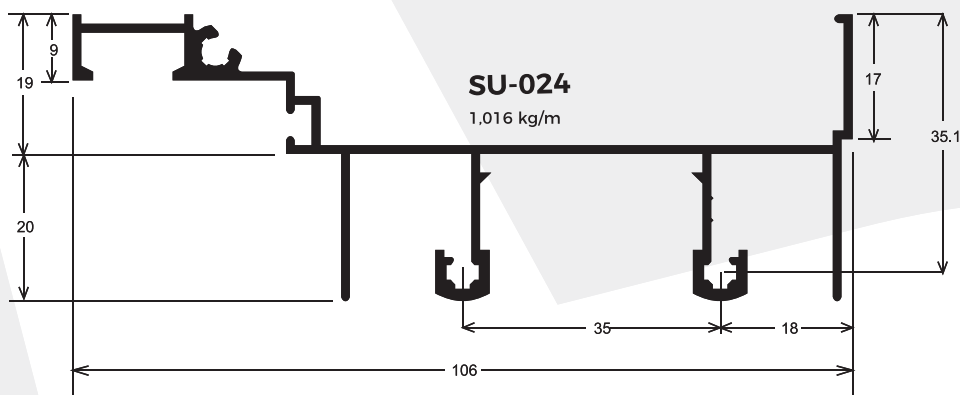
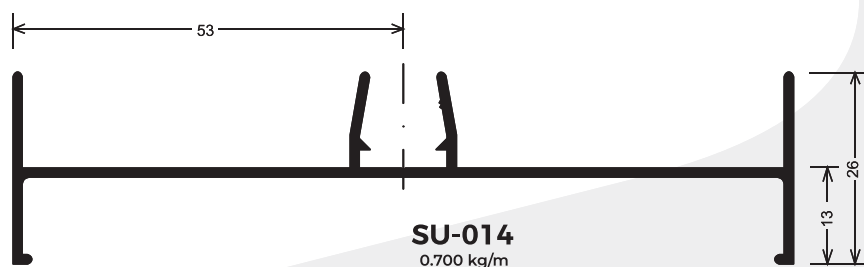
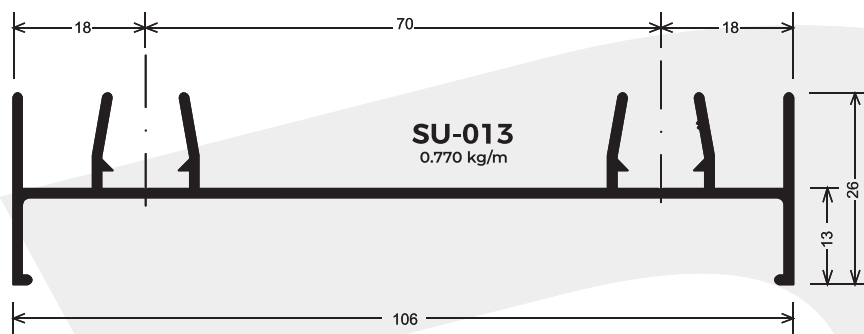



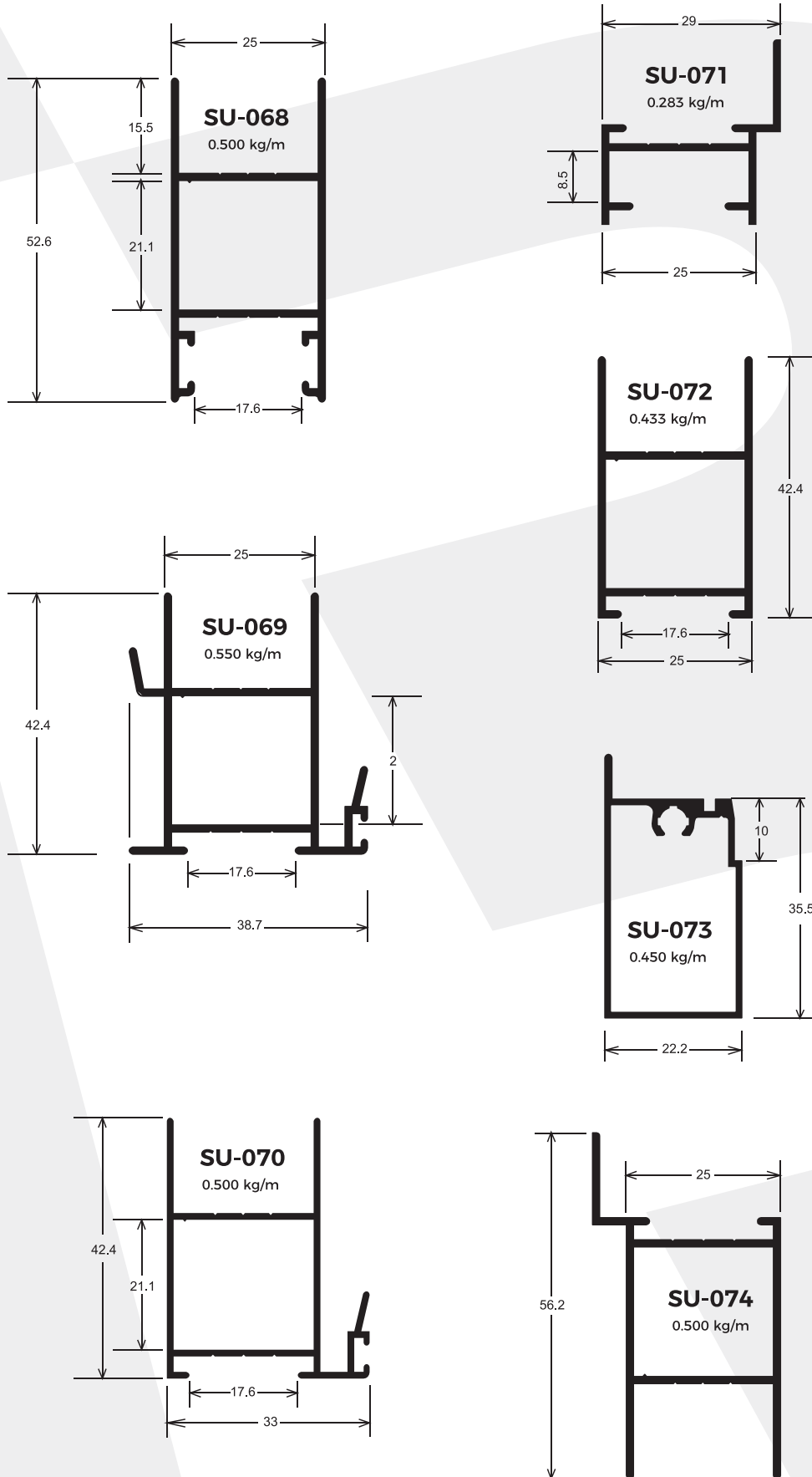

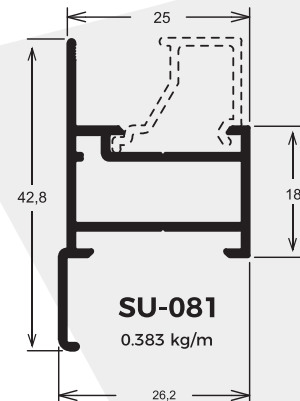
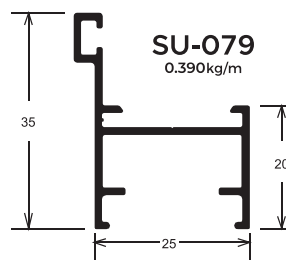
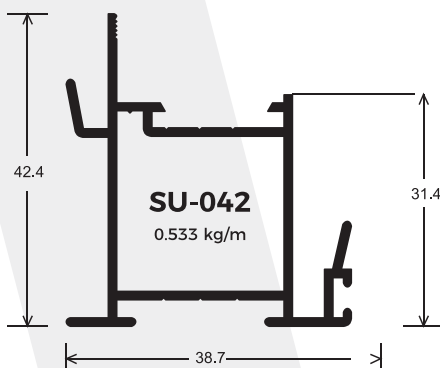
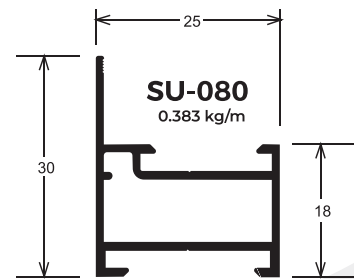
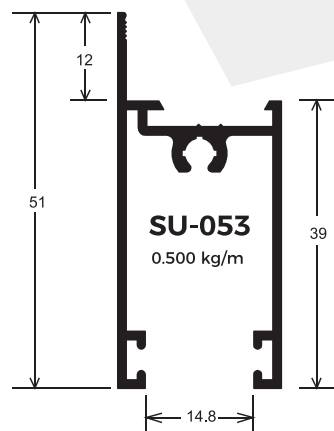
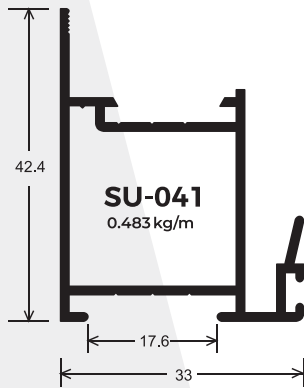
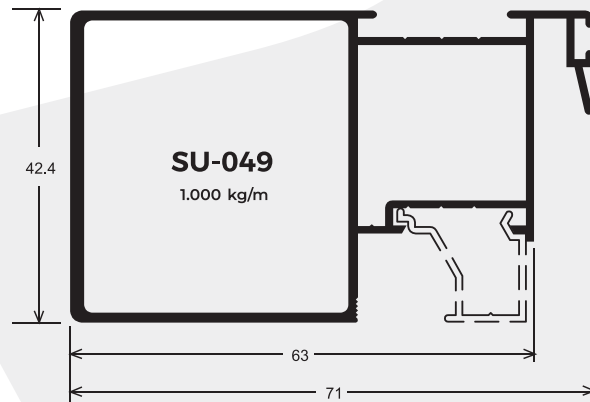
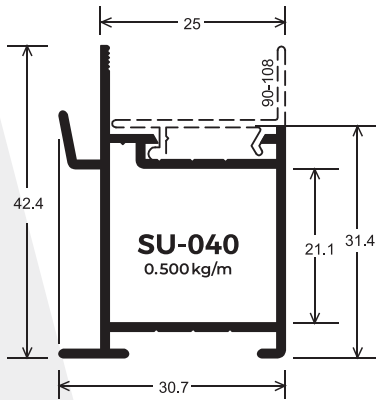
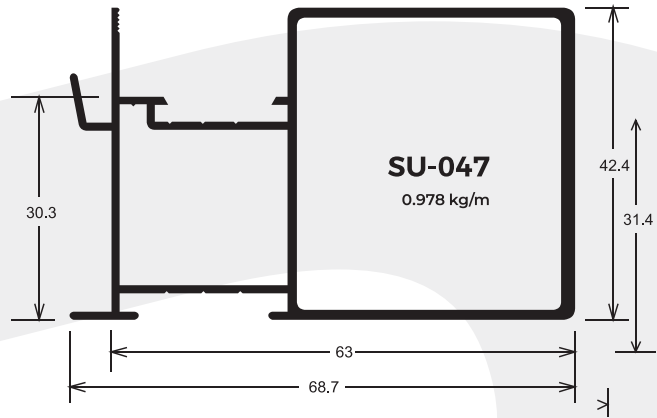
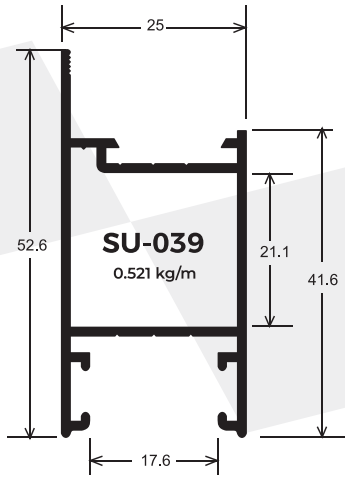

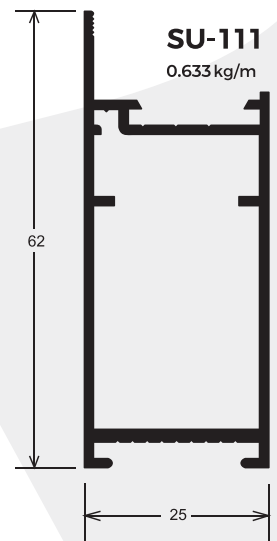
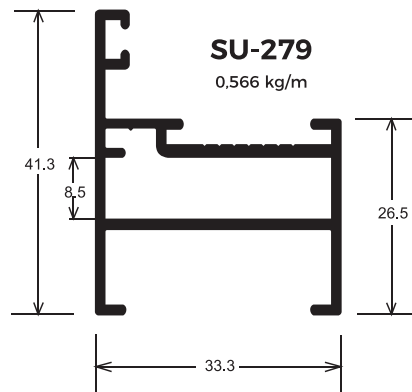
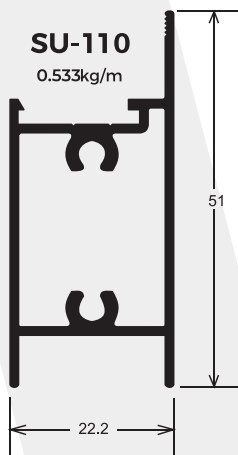
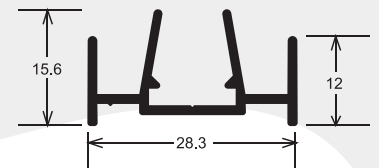
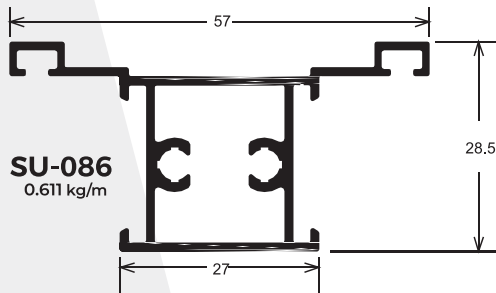
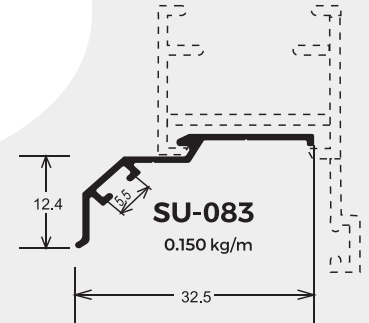
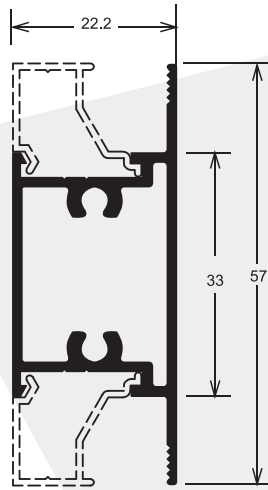
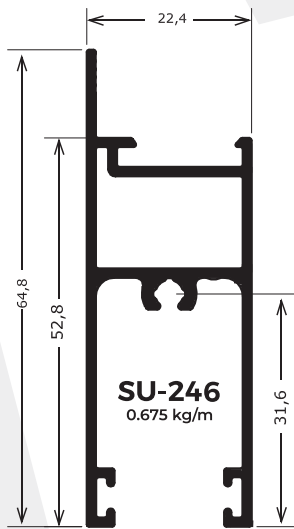
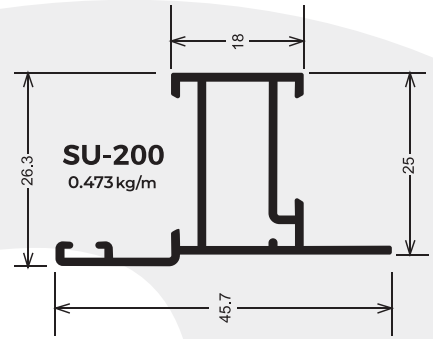
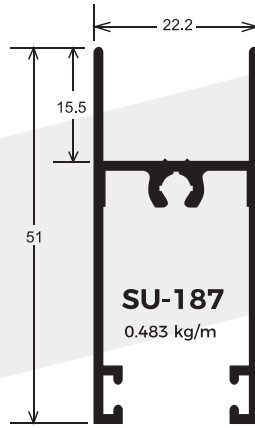
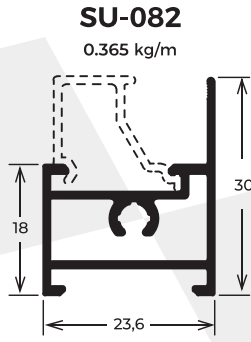

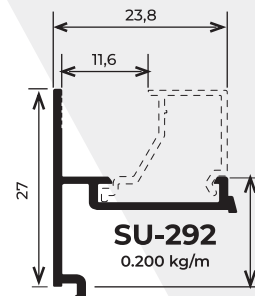
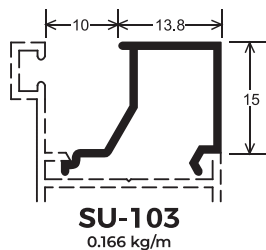
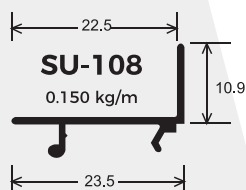
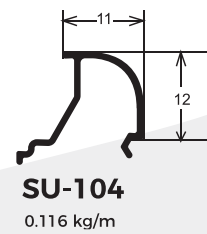
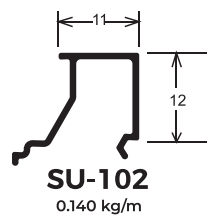
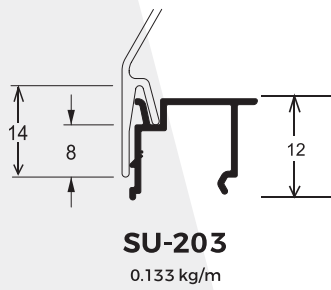
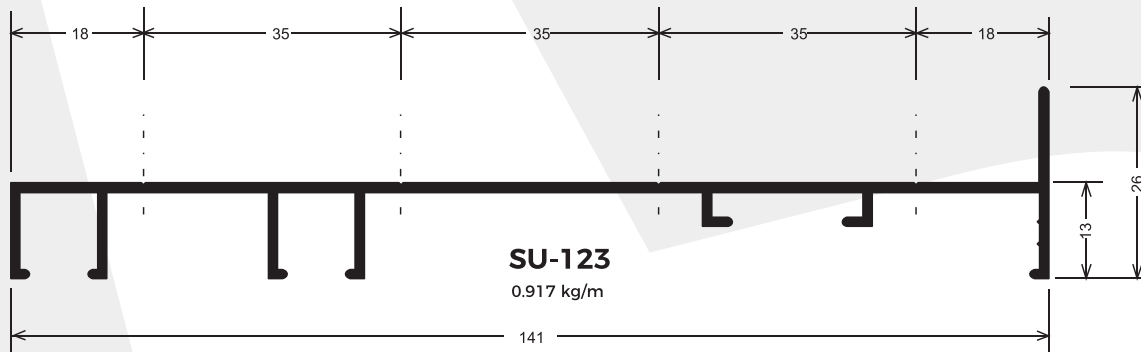
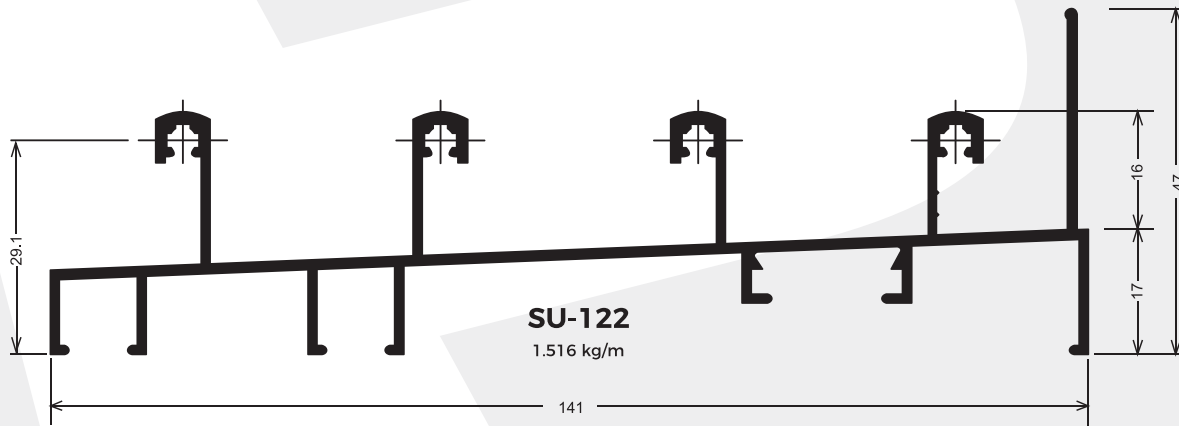
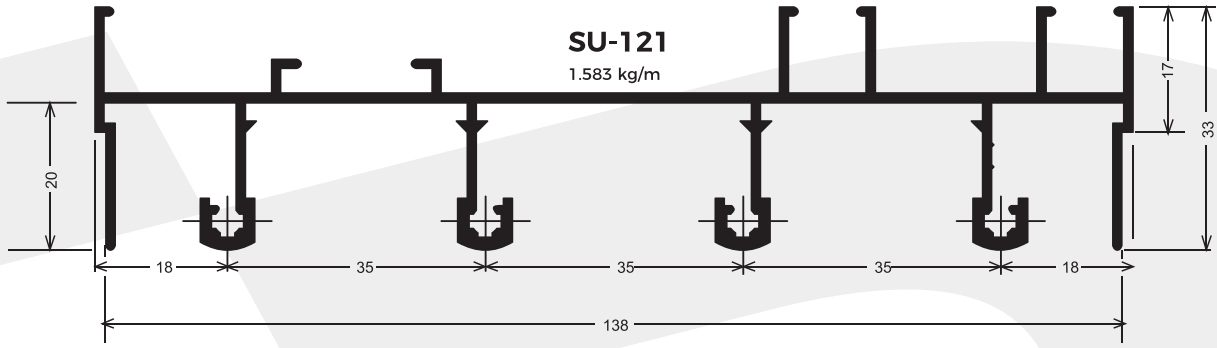

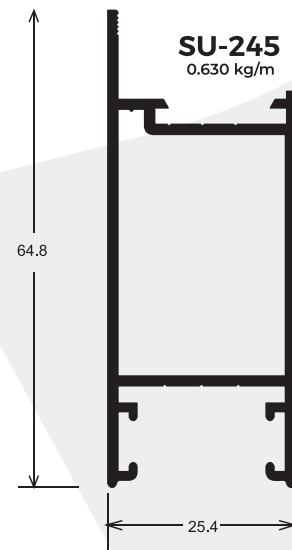
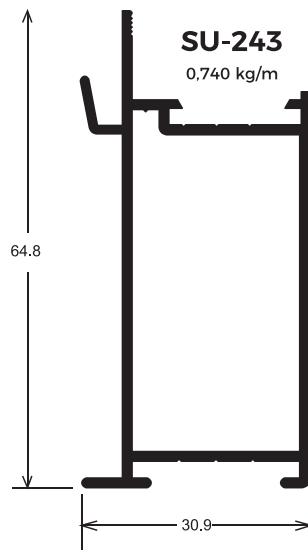
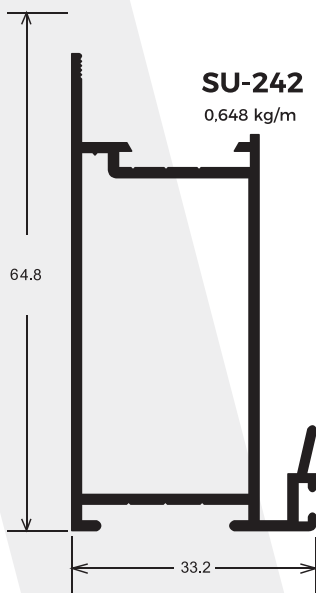
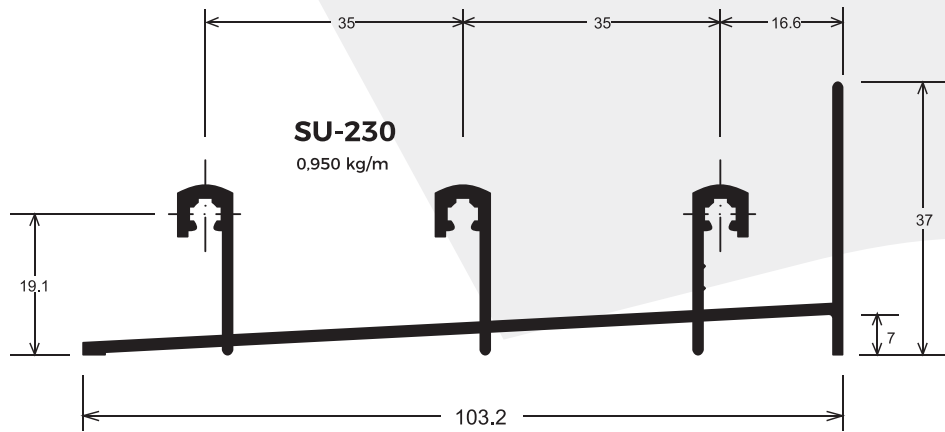
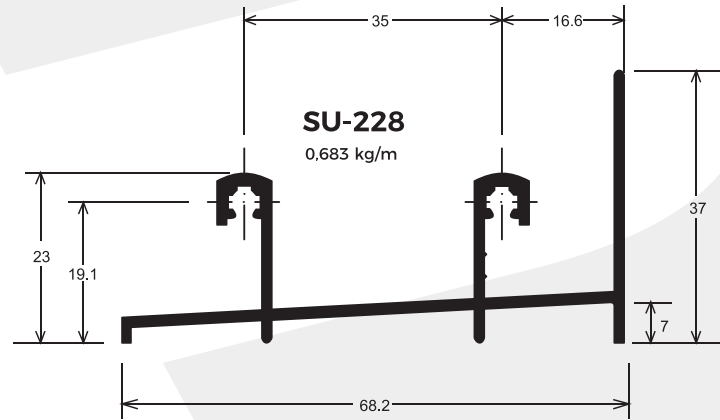
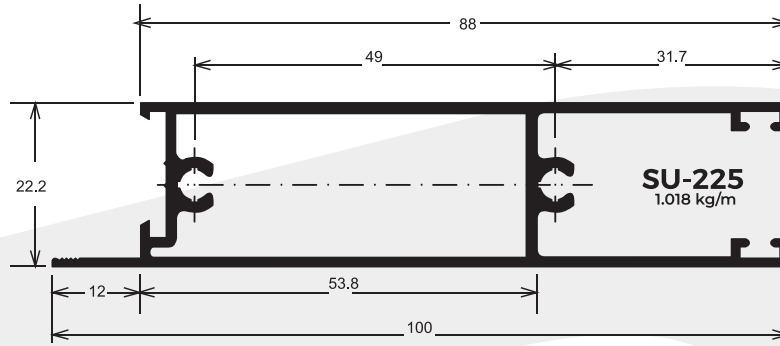

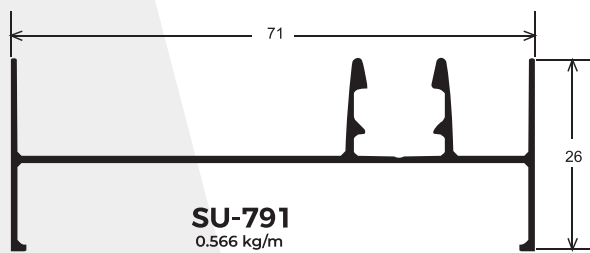
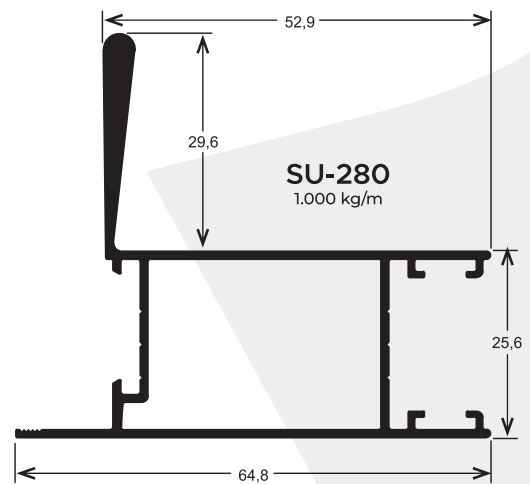
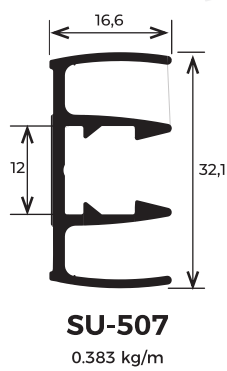
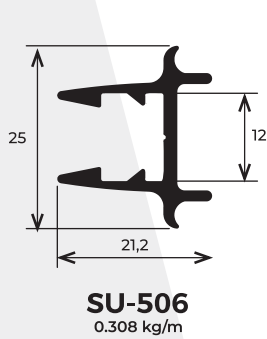
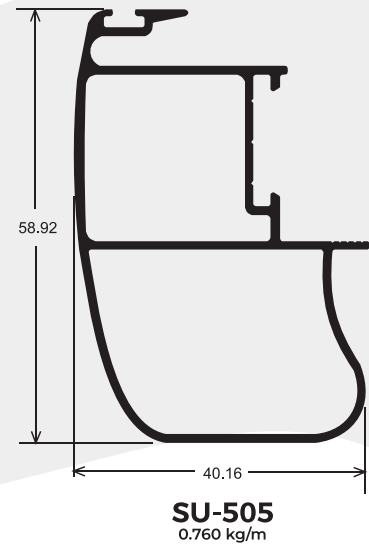
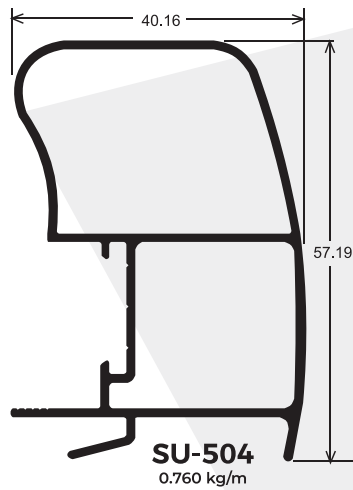
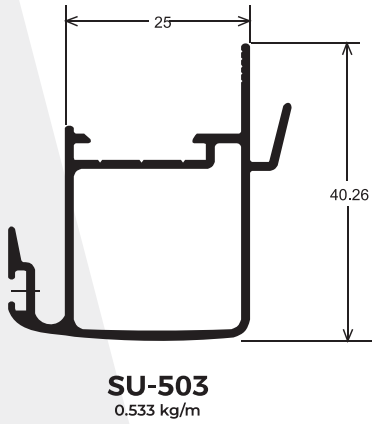
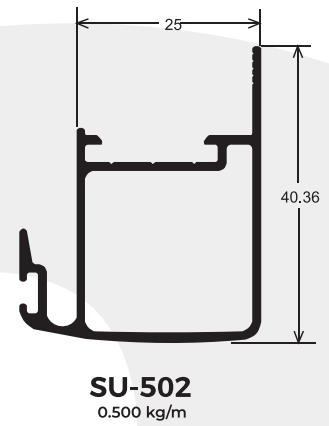
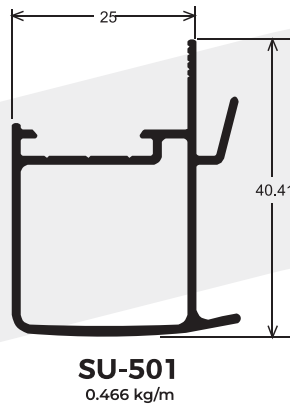
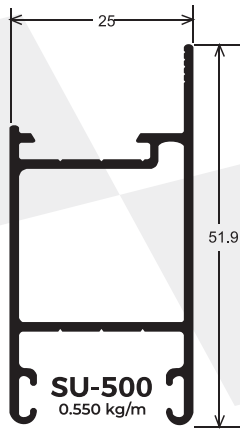

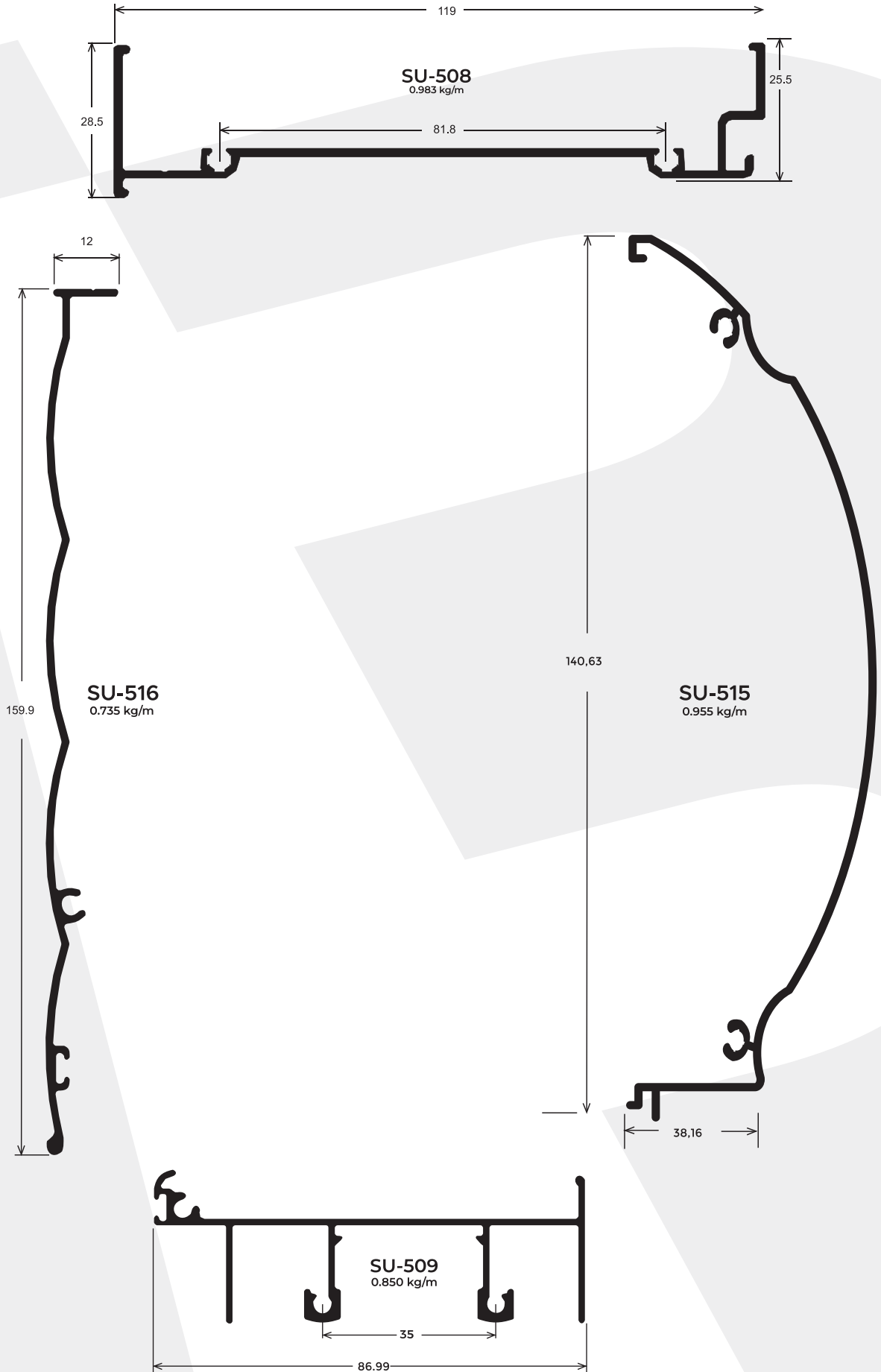

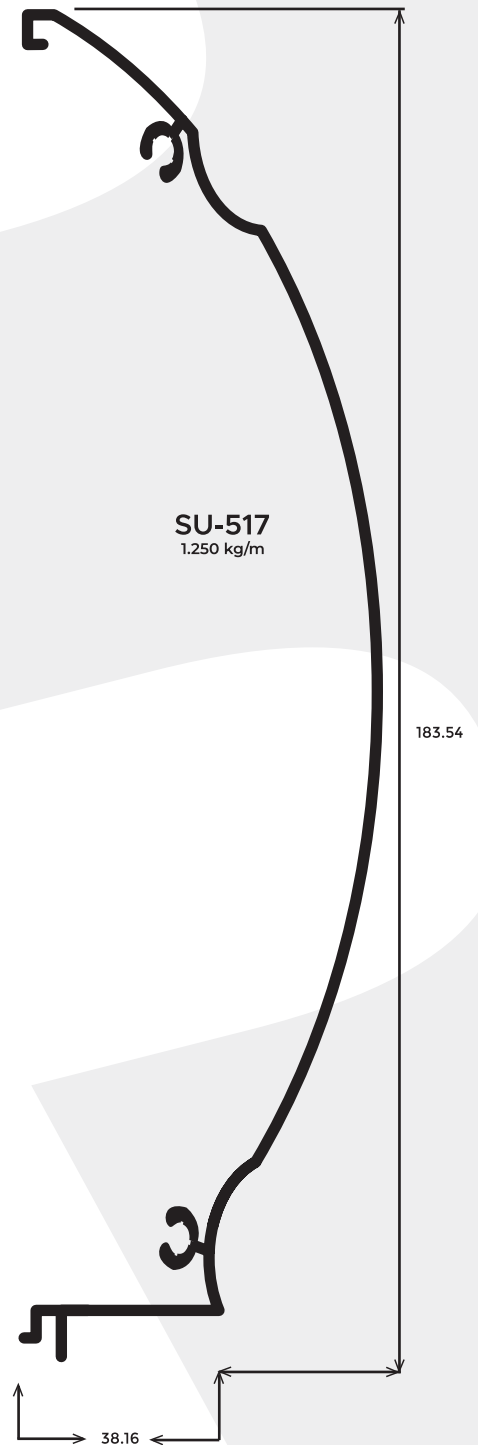
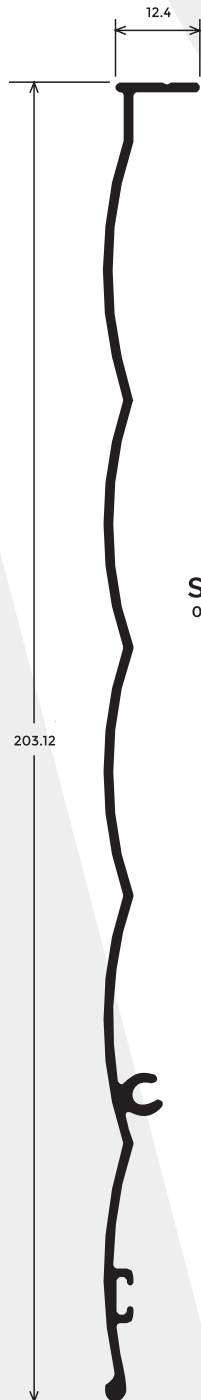
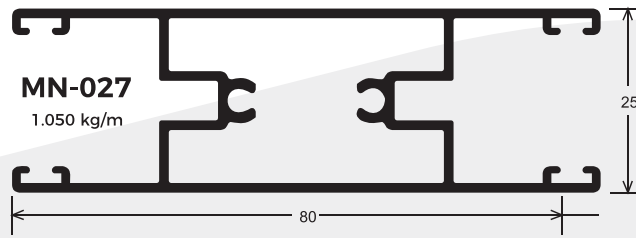



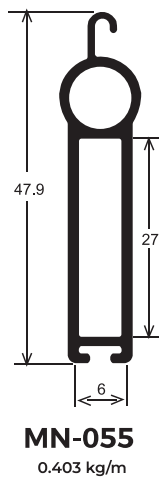
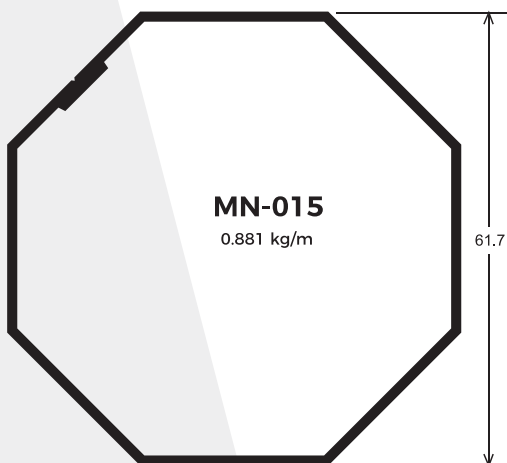
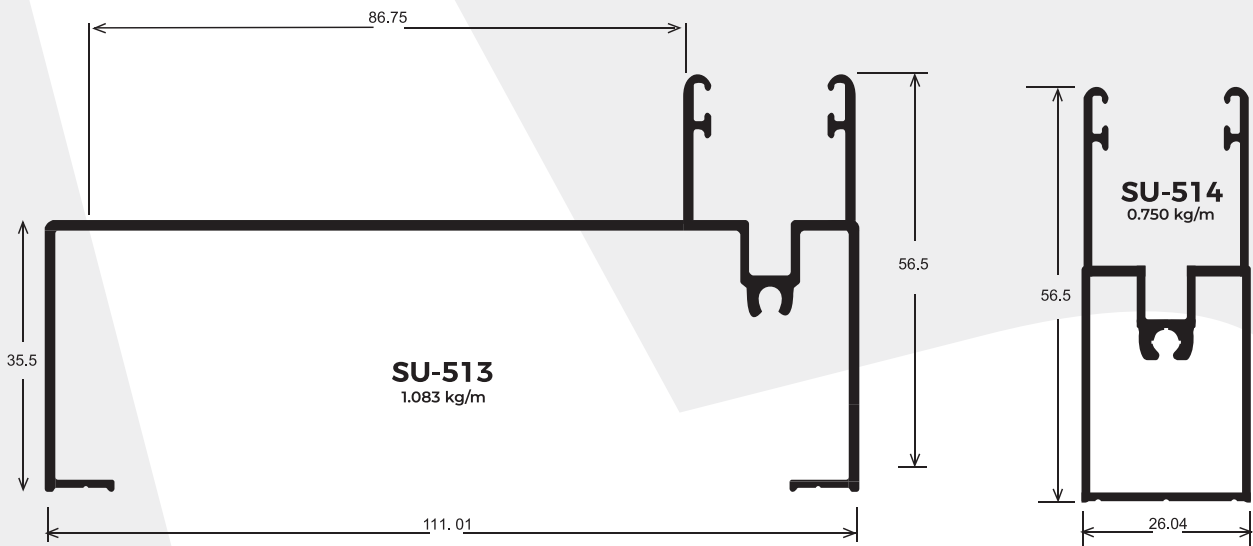
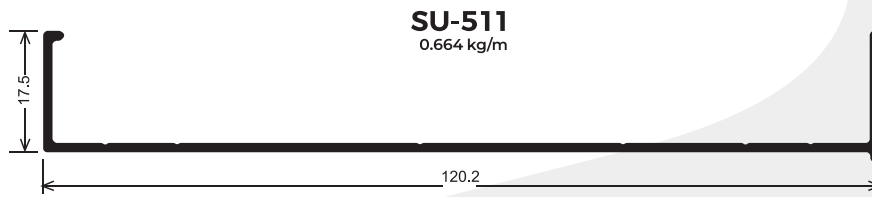
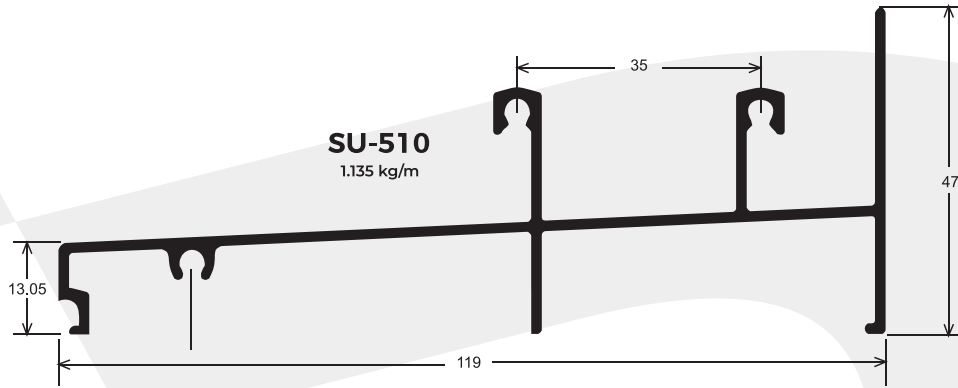

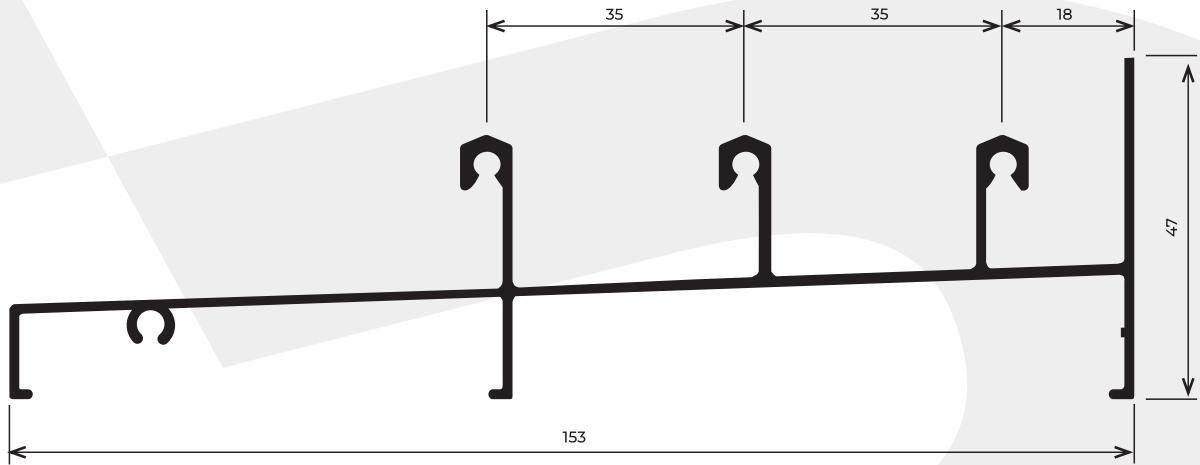

**SU-333**  
1.366 kg/m

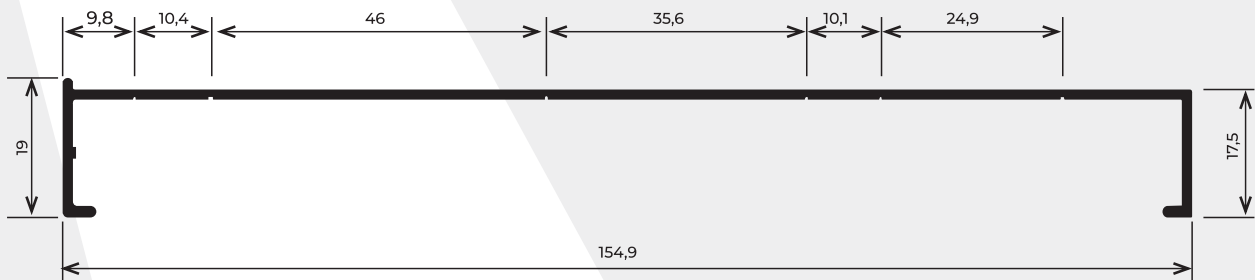

**SU-336**  
0.800 kg/m

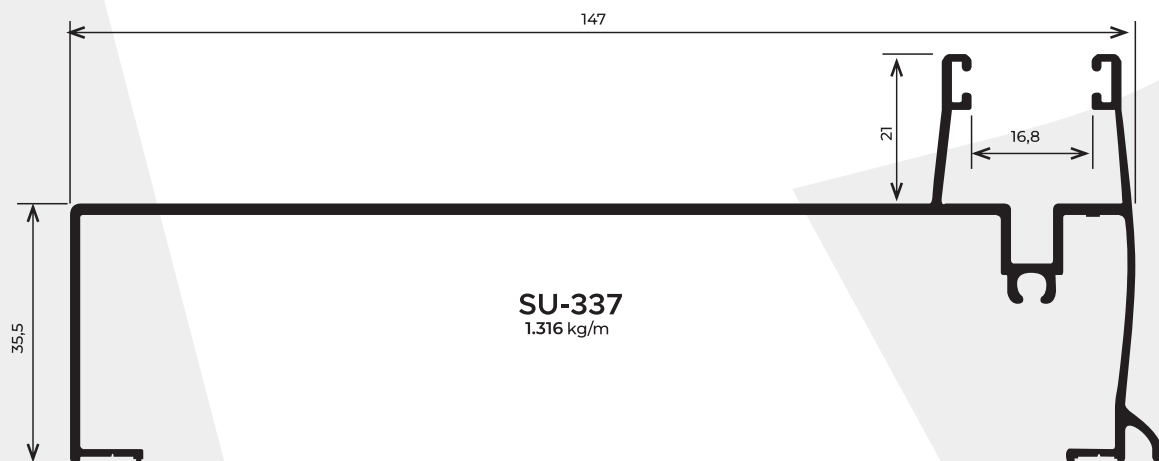

**SU-337**  
1.316 kg/m

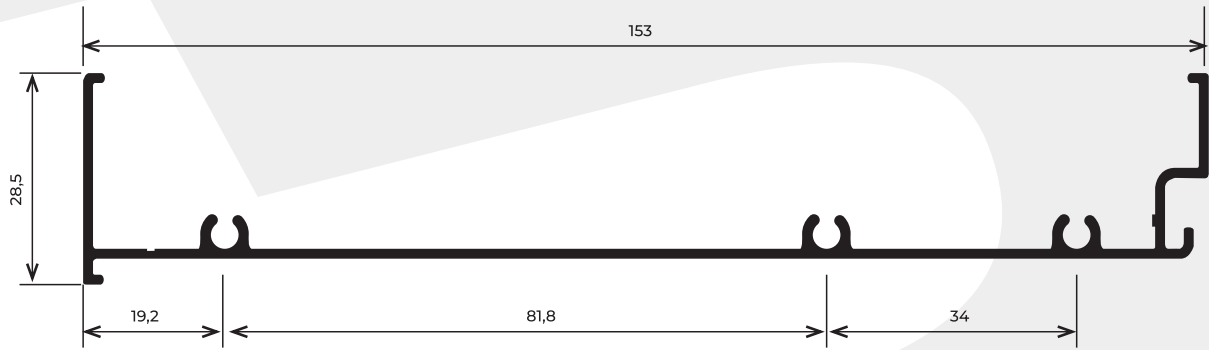

**SU-334**  
1.033 kg/m

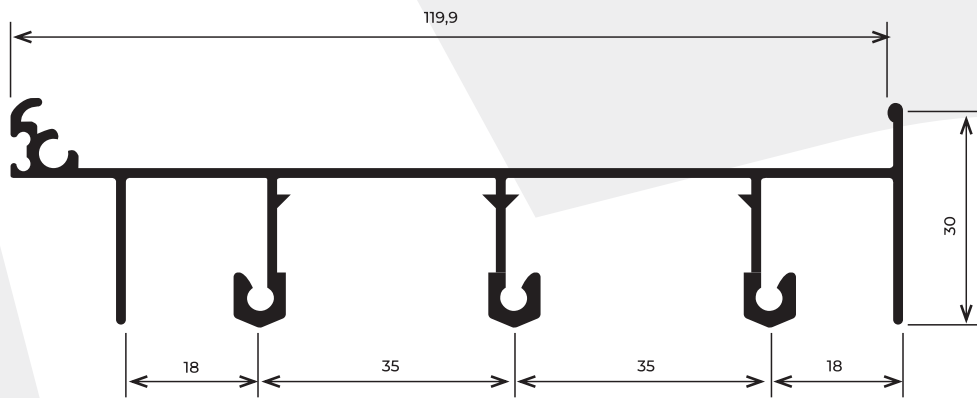

**SU-335**  
1.250 kg/m

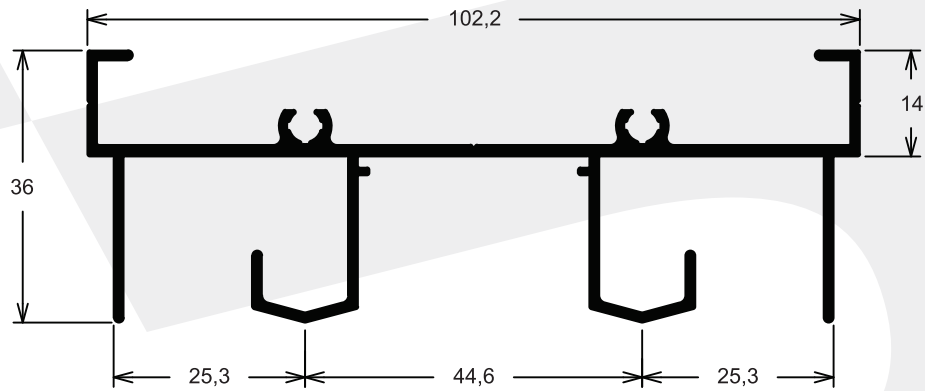

**LG-044**

1,018 kg/m

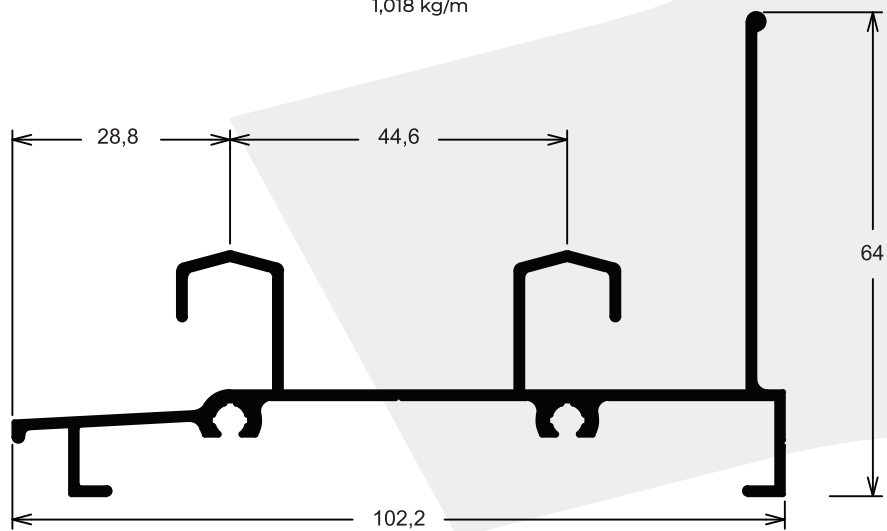

**LG-024**

1,266 kg/m

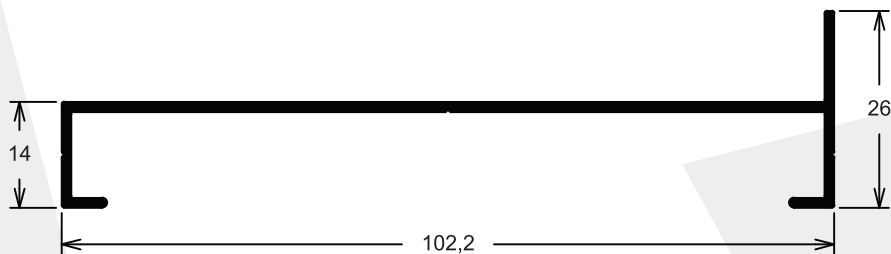

**LG-002**

0,586 kg/m

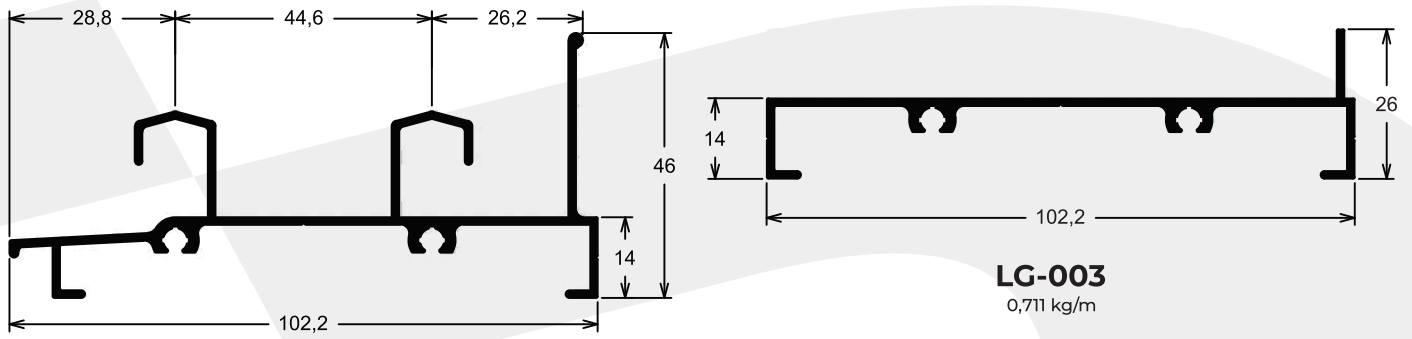

**LG-047**  
0,956 kg/m

**LG-003**  
0,711 kg/m

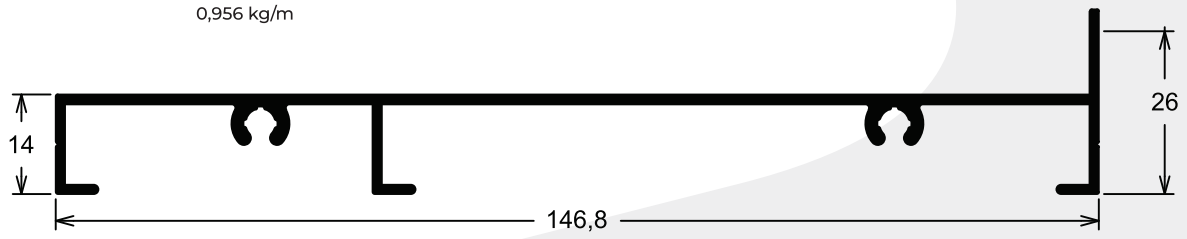

**LG-158**  
0,933 kg/m

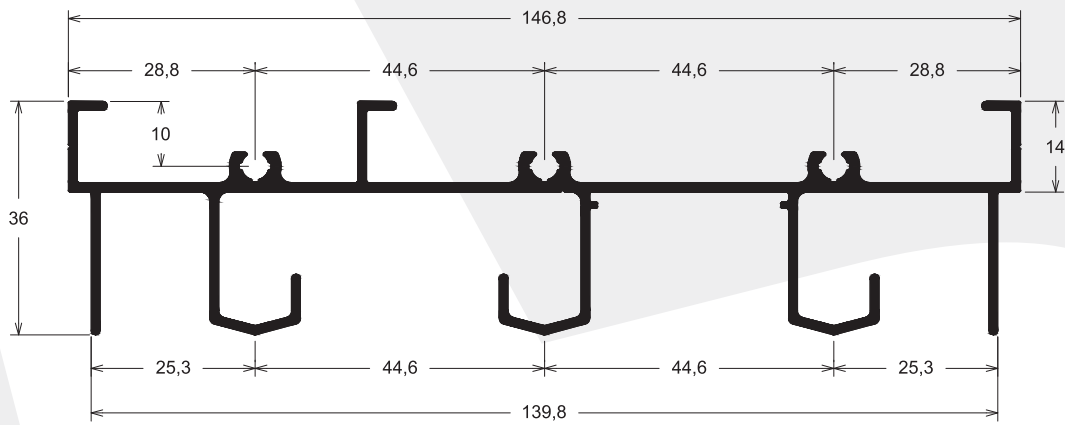

**LG-062**  
1,590 kg/m

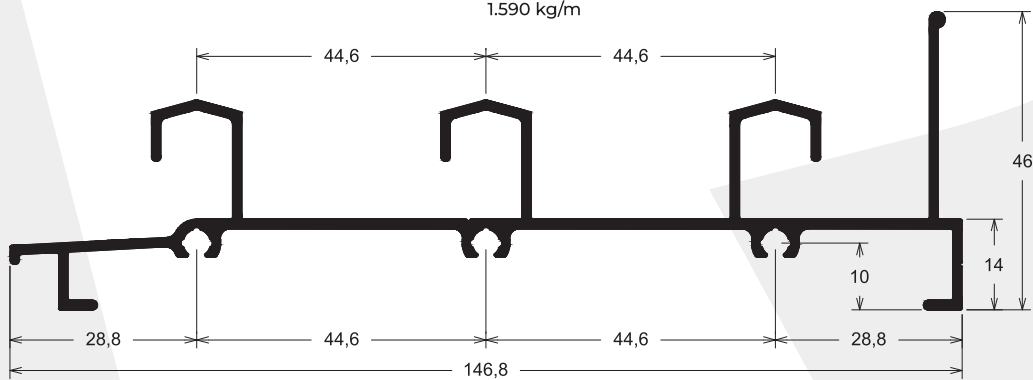

**LG-066**  
1,417 kg/m

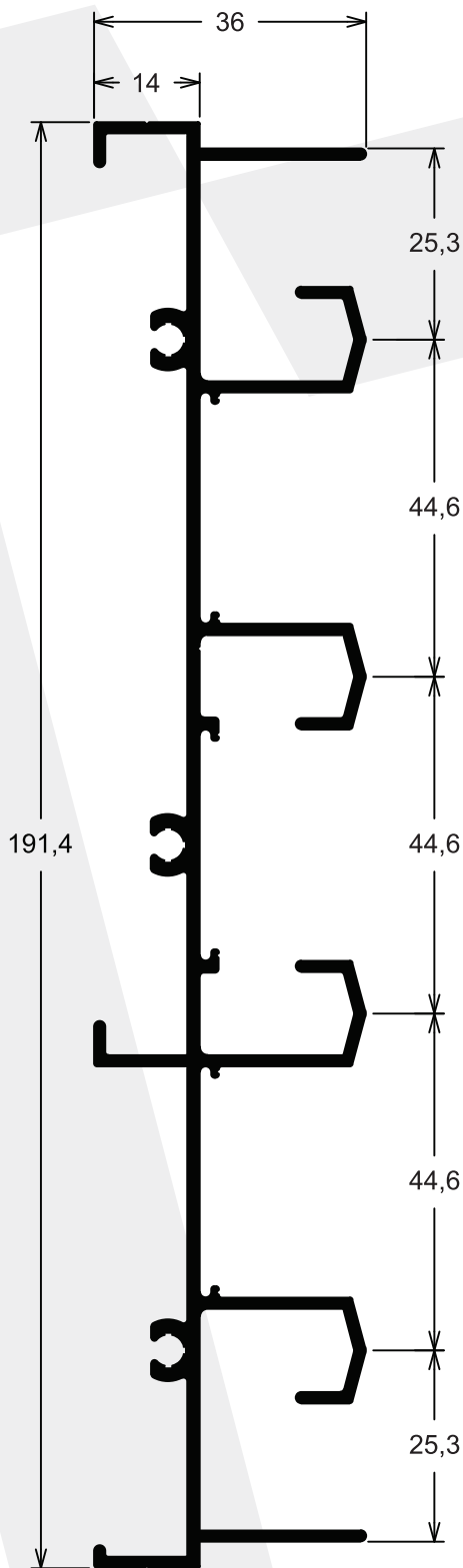

**LG-070**

2,116 kg/m

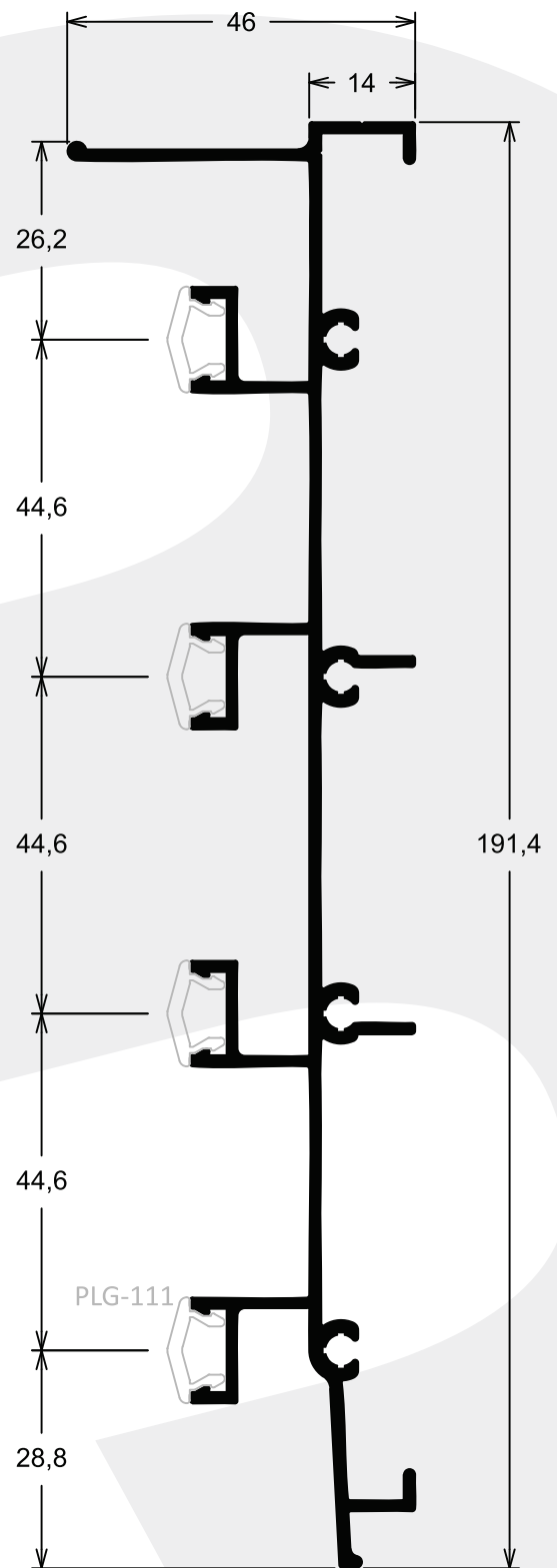

**LG-160**

1,818 kg/m

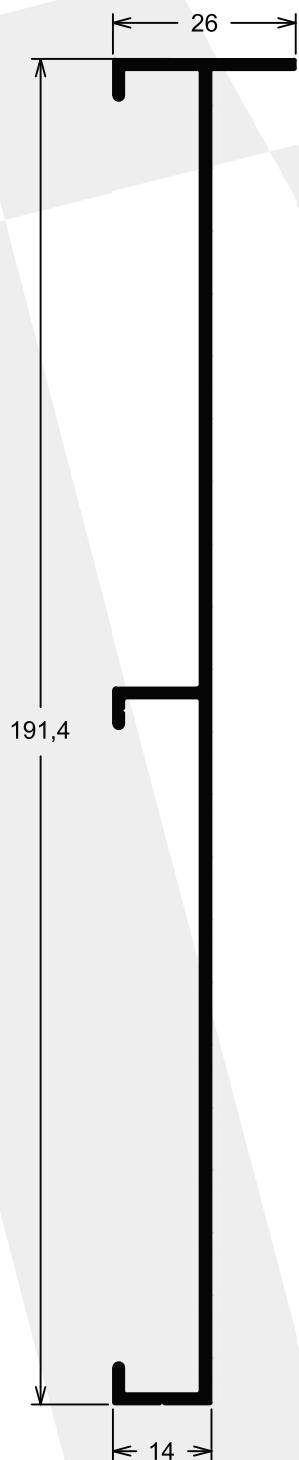

**LG-072**  
1,160 kg/m

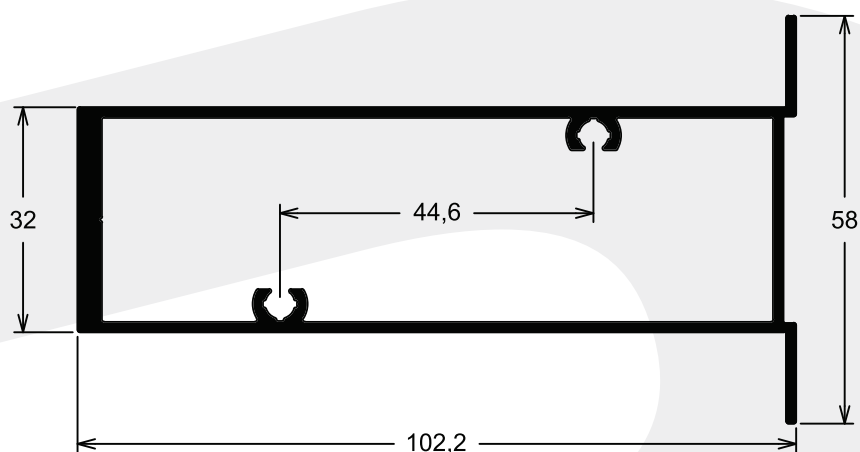

**LG-176**  
1,530 kg/m

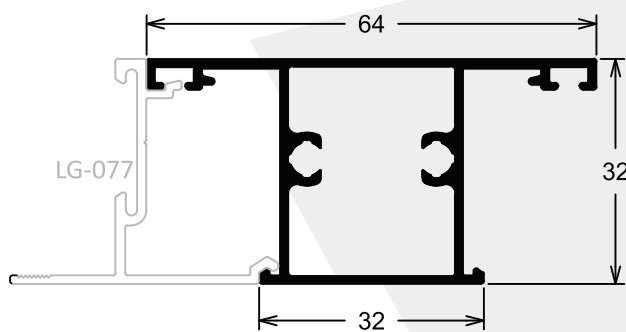

**LG-074**  
0,730 kg/m

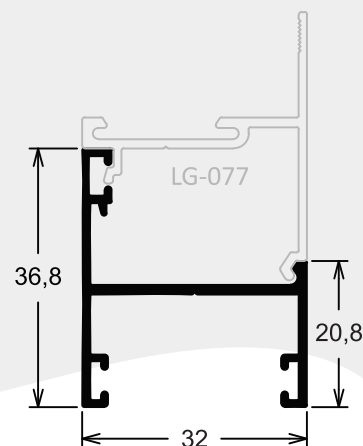

**LG-068**  
0,356 kg/m

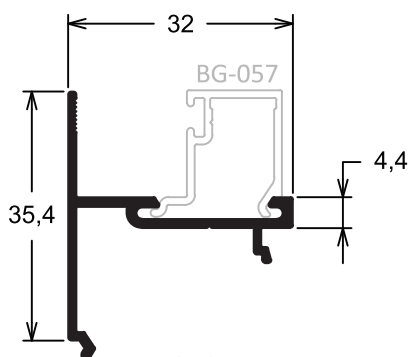

**LG-077**  
0,333 kg/m

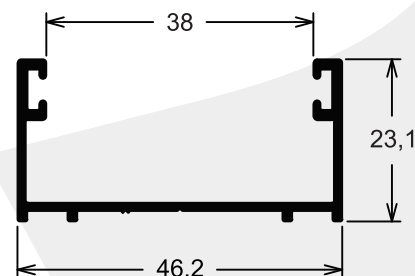

**LG-028**  
0,370 kg/m

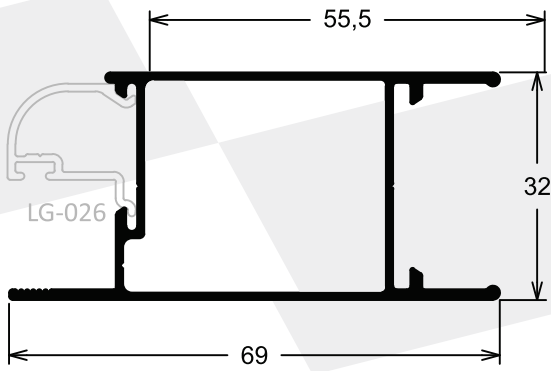

**LG-050**

0,686 kg/m

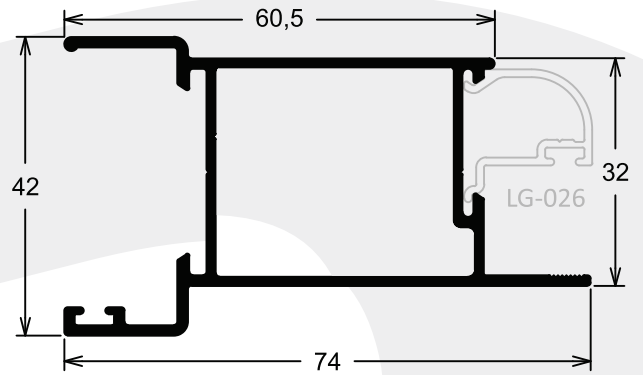

**LG-051**

0,751 kg/m

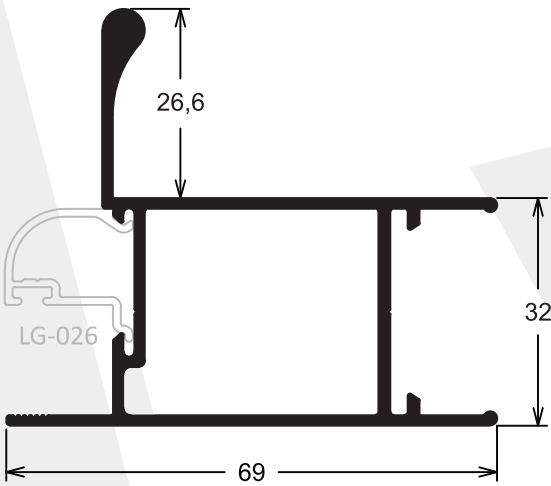

**LG-017**

1,008 kg/m

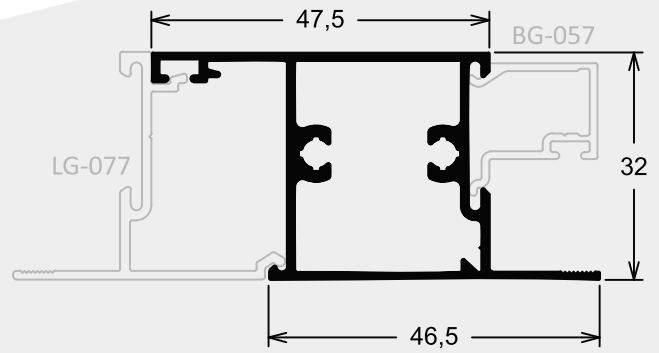

**LG-076**

0,766 kg/m

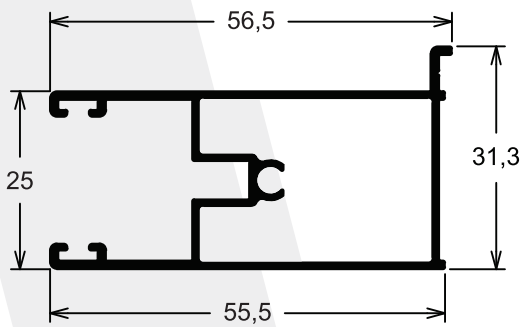

**MN-007**

0,716 kg/m

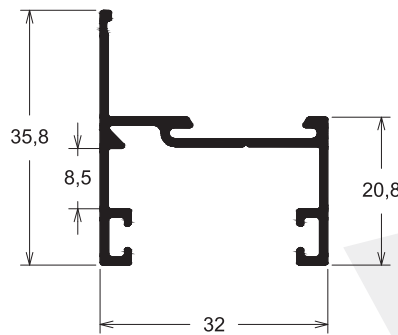

**LG-083**

0,368 kg/m

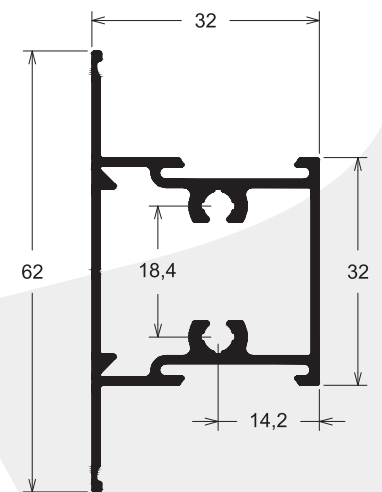

**LG-079**

0,696 kg/m



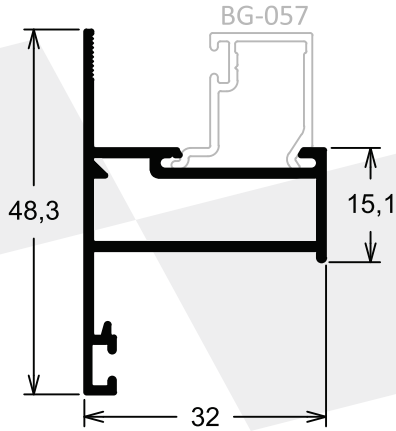

**LG-085**  
0,426 kg/m

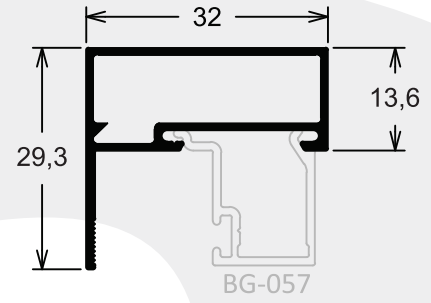

**PLG-071**  
0,336 kg/m

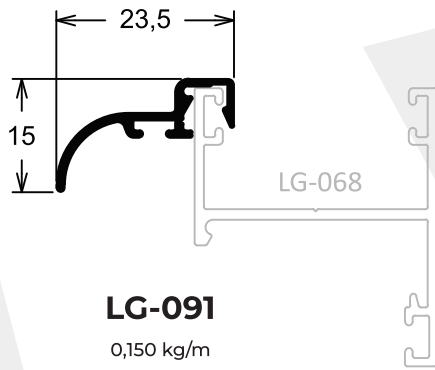

**LG-091**  
0,150 kg/m

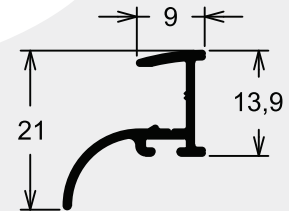

**LG-092**  
0,145 kg/m

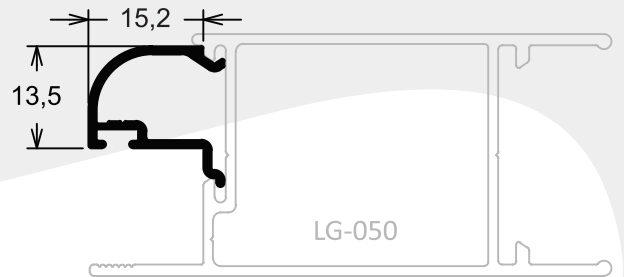

**LG-026**  
0,155 kg/m

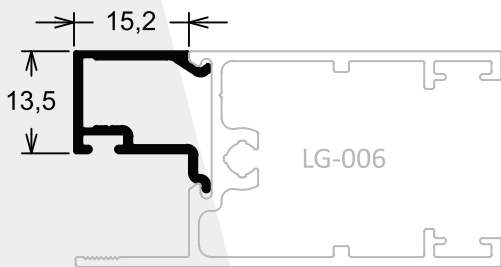

**BG-057**  
0,166 kg/m

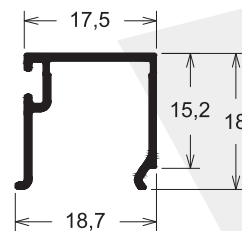

**LG-059**  
0,157 kg/m

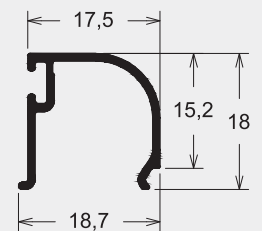

**LG-164**  
0,148 kg/m

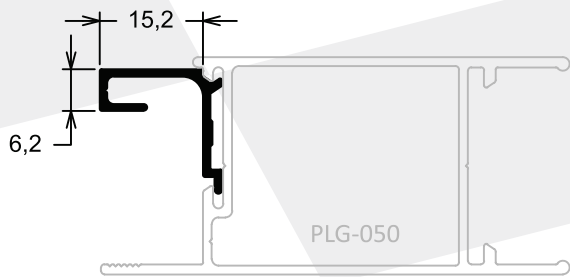

**LG-027**  
0,146 kg/m

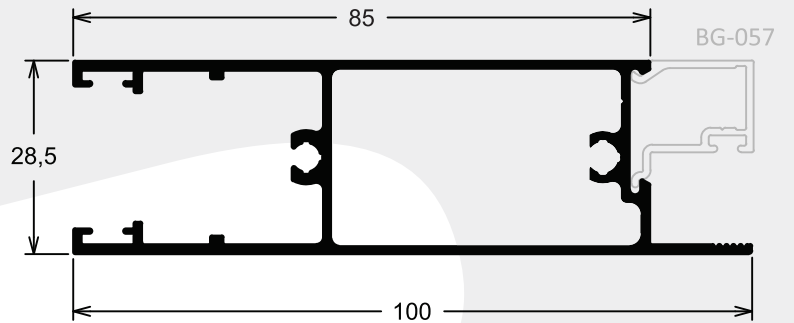

**LG-007**  
1,083 kg/m

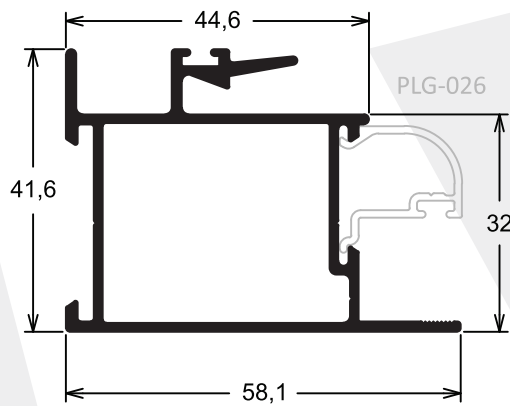

**LG-049**  
0,771 kg/m

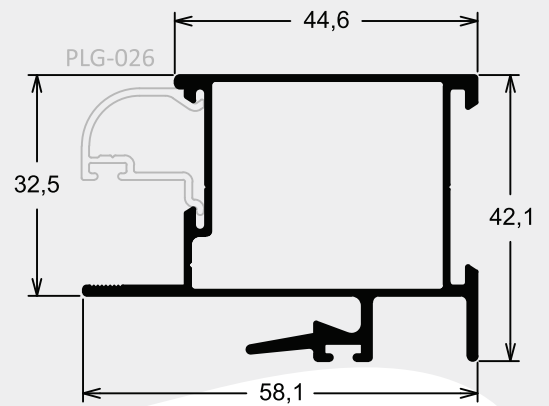

**LG-048**  
0,746 kg/m

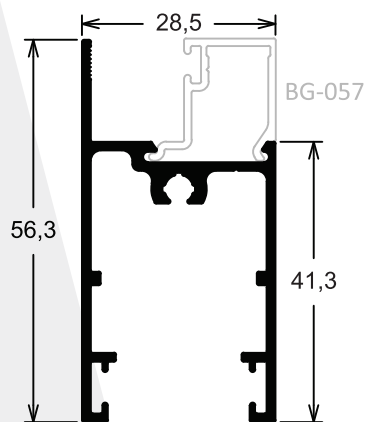

**LG-006**  
0,576 kg/m

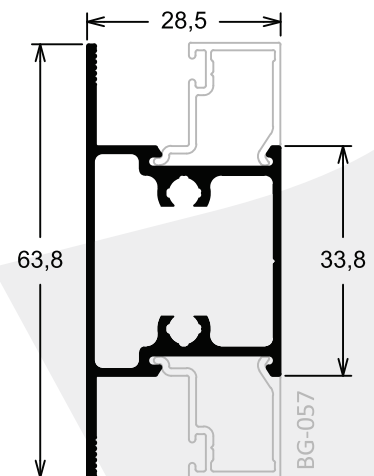

**LG-055**  
0,698 kg/m

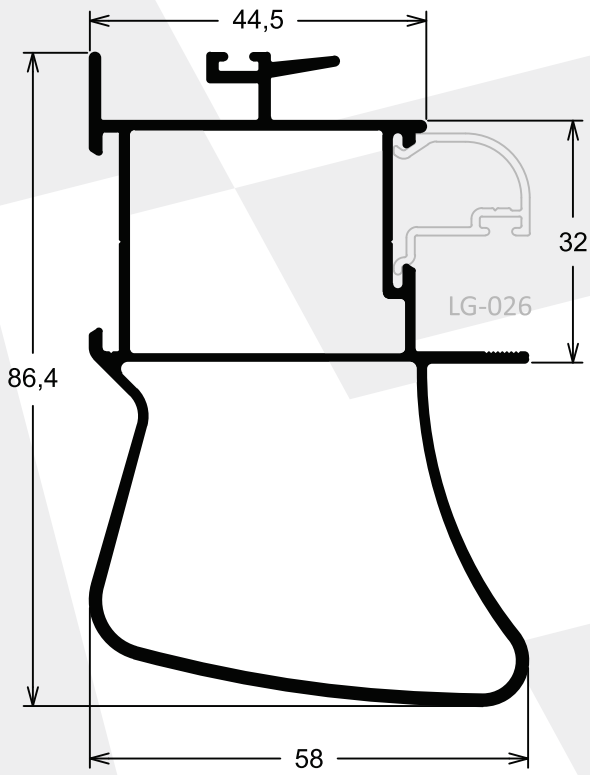

**LG-140**

1,461 kg/m

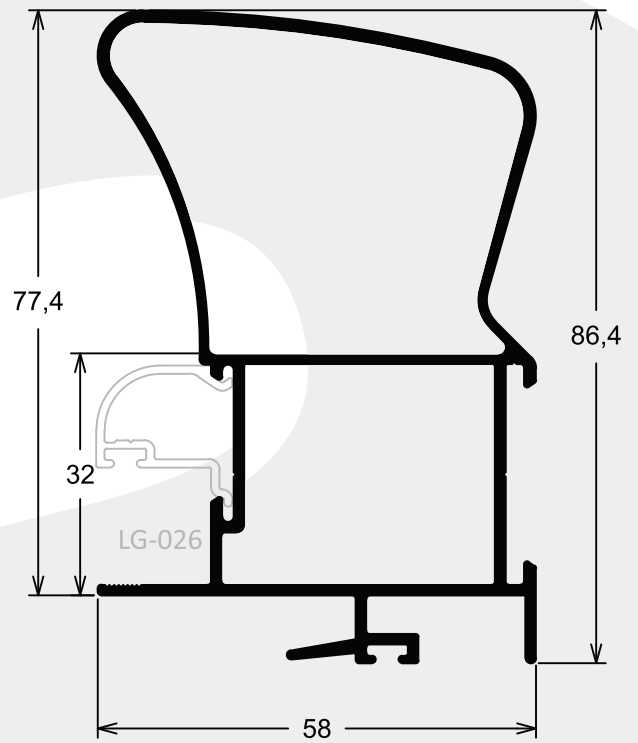

**LG-137**

1,452 kg/m

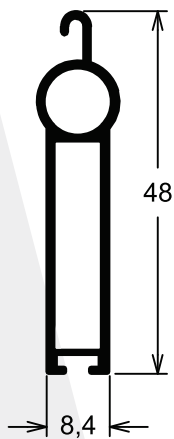

**MN-055**

0,400 kg/m

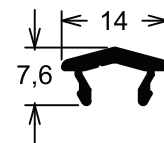

**LG-111**

0,095 kg/m

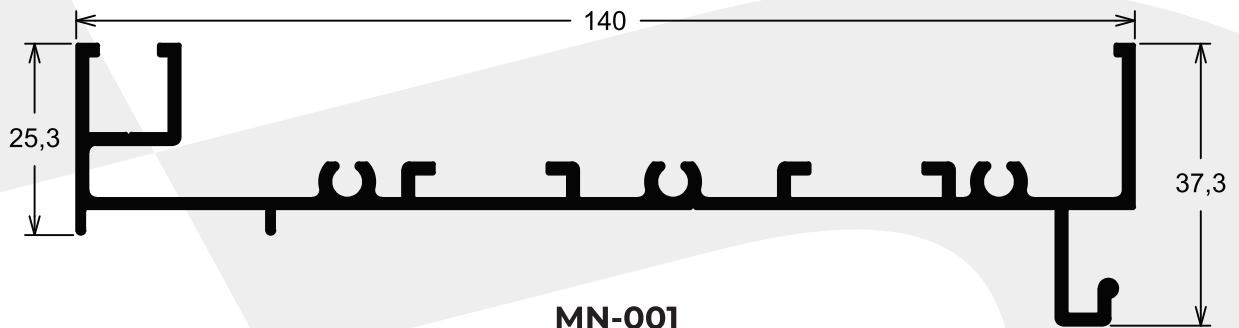

**MN-001**

1,303 kg/m

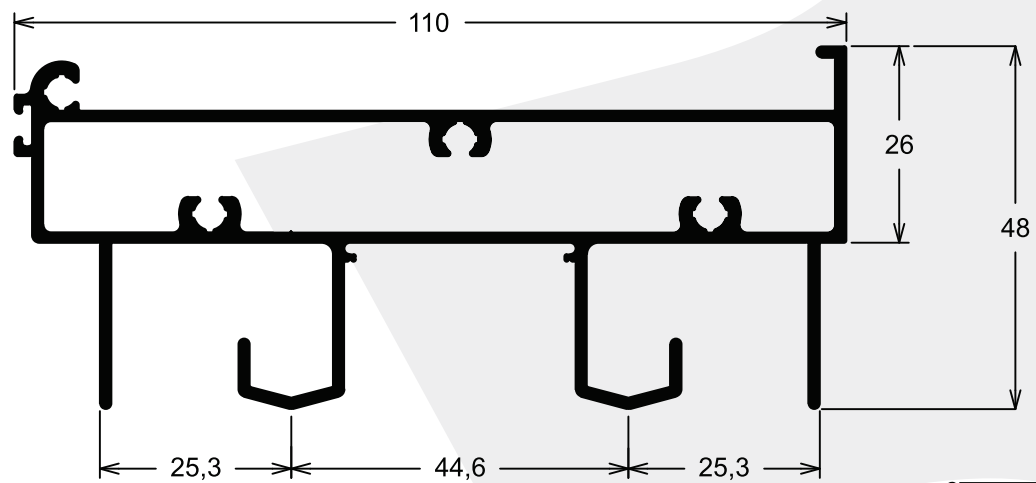

**LG-166**

1,745 kg/m

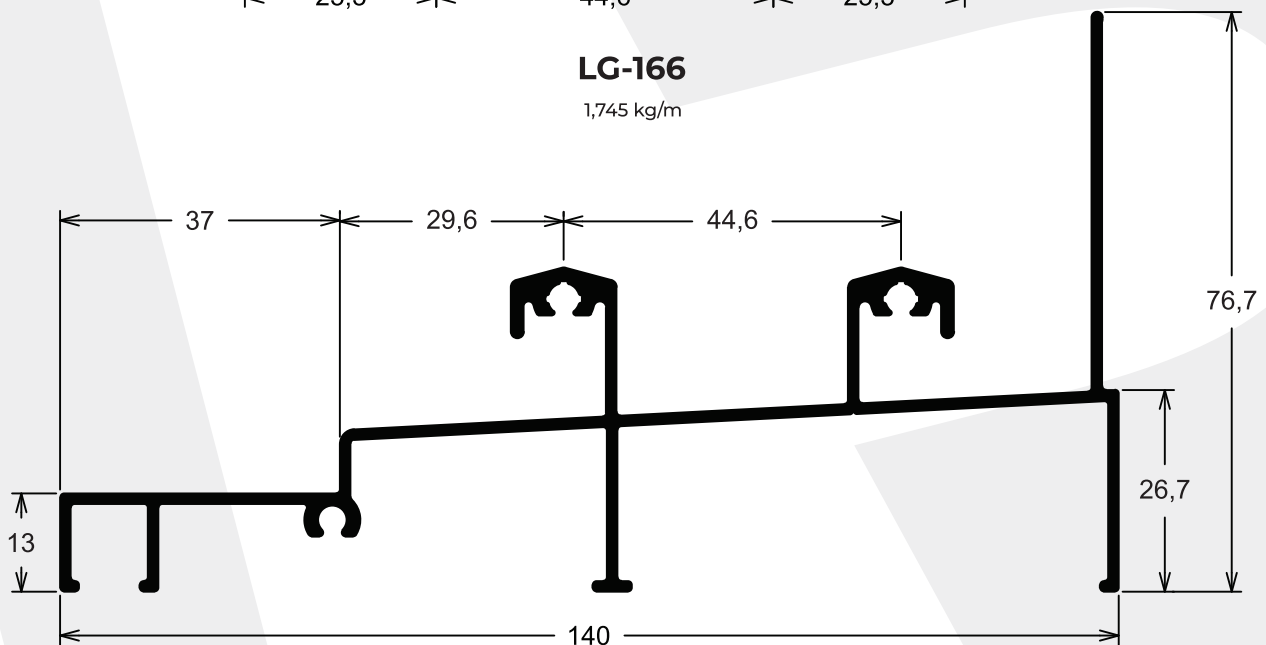

**LG-030**

1,556 kg/m

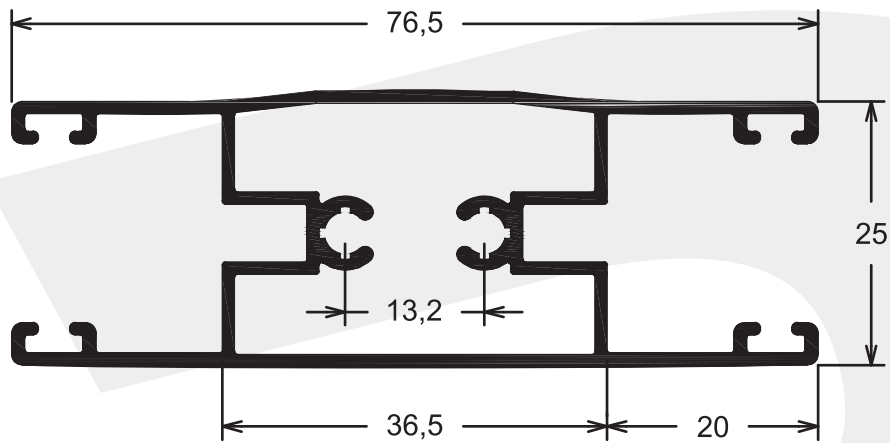

**PIT-018**  
0,892 kg/m

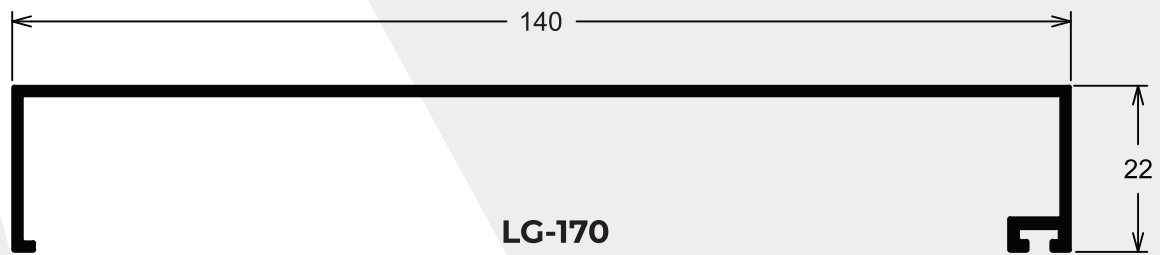

**LG-170**  
0,825 kg/m



**LG-236**  
1,190 kg/m

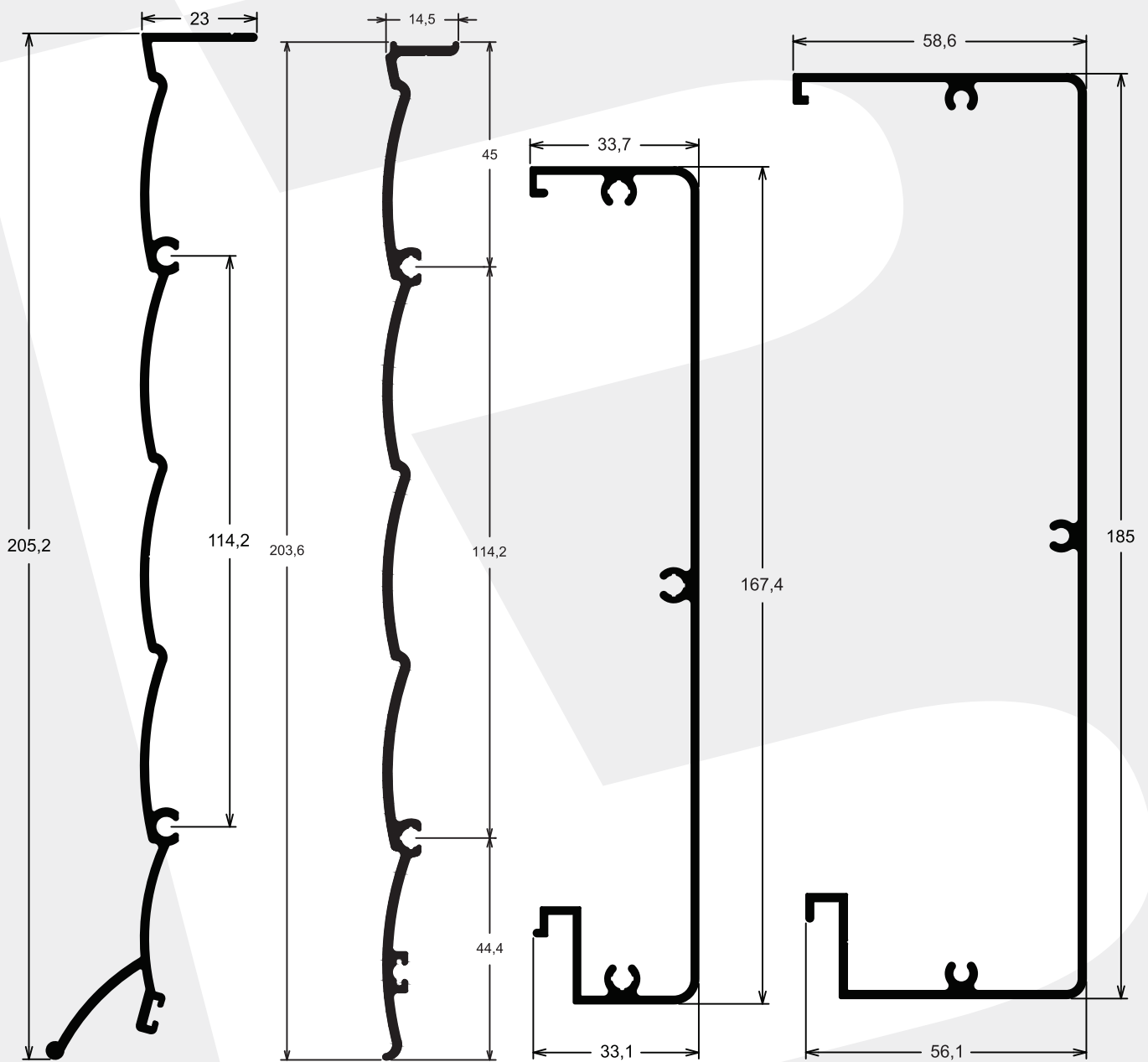

**MN-039**  
1,248 kg/m

**PIT-039**  
1,168 kg/m

**MN-031**  
1,316 kg/m

**LG-230**  
1,573 kg/m

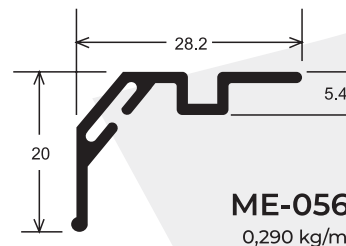
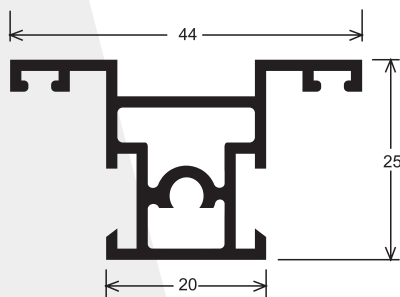
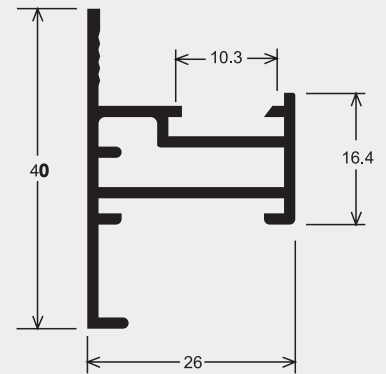
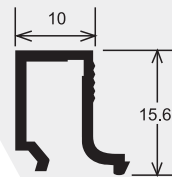
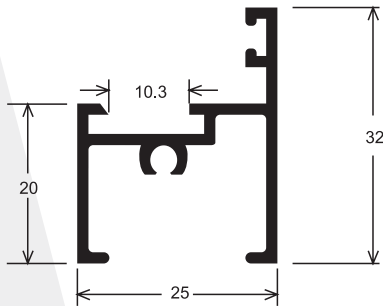
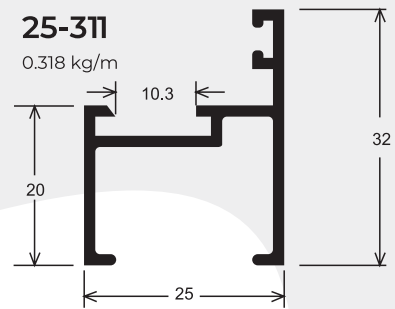
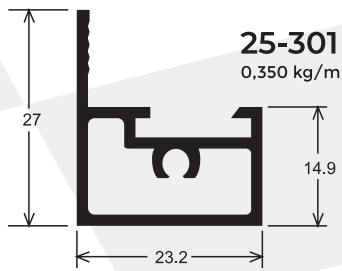

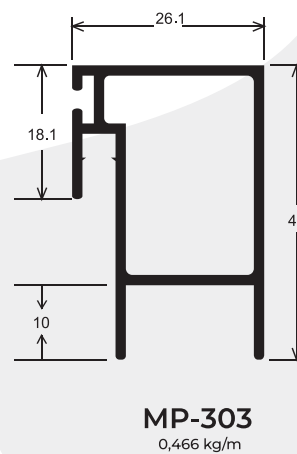
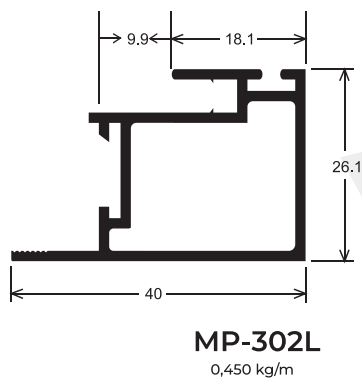
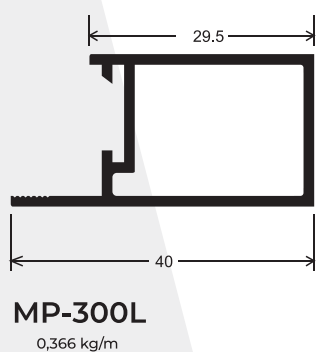
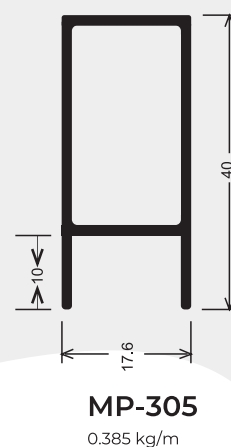
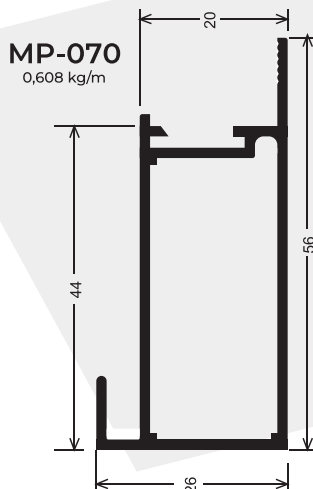
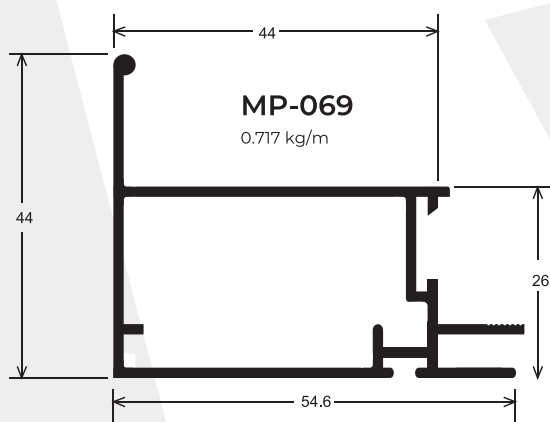
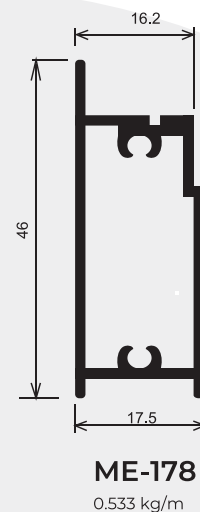
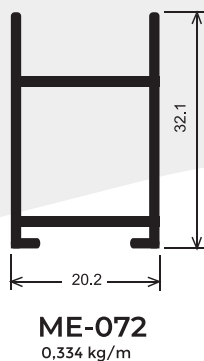
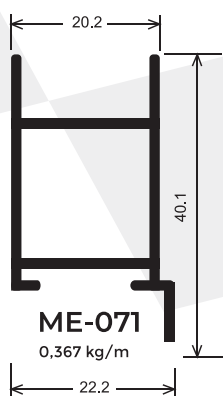



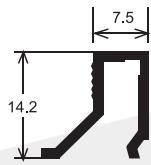

**BG-202**  
0.100 kg/m

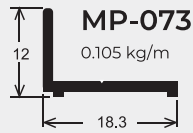

**MP-073**  
0.105 kg/m

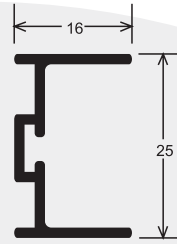

**MP-352**  
0.199 kg/m

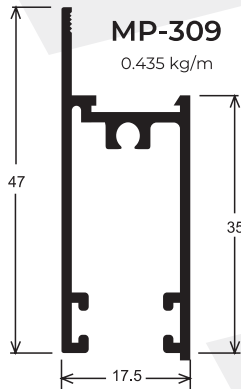

**MP-309**  
0.435 kg/m

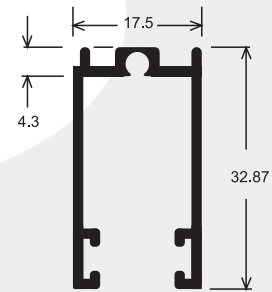

**MP-378**  
0.350 kg/m

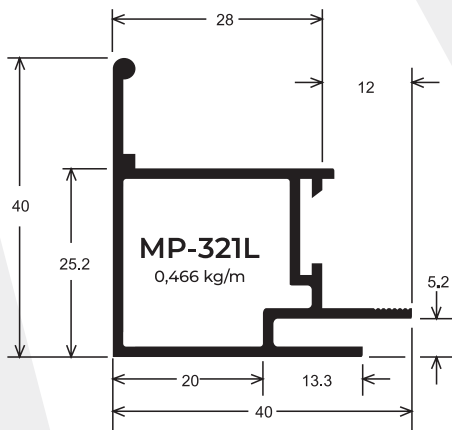

**MP-321L**  
0.466 kg/m

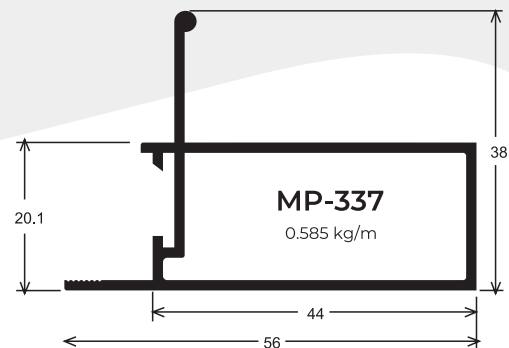

**MP-337**  
0.585 kg/m

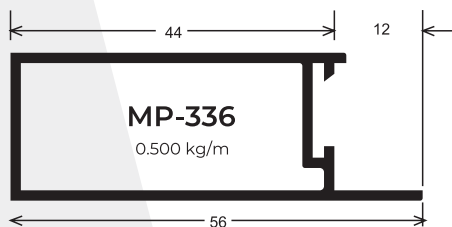

**MP-336**  
0.500 kg/m

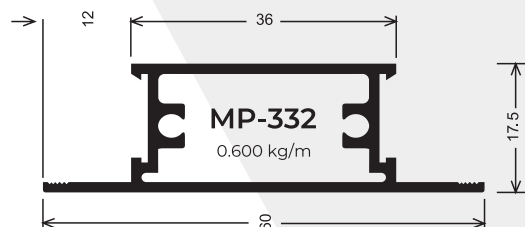

**MP-332**  
0.600 kg/m

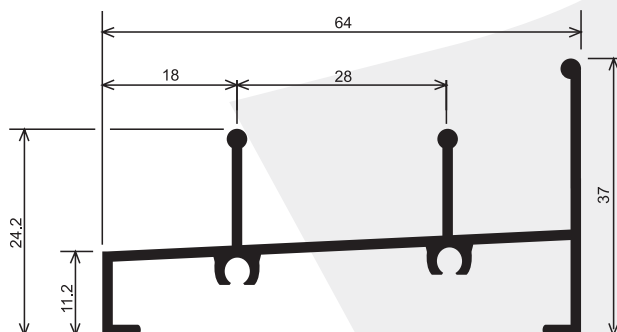
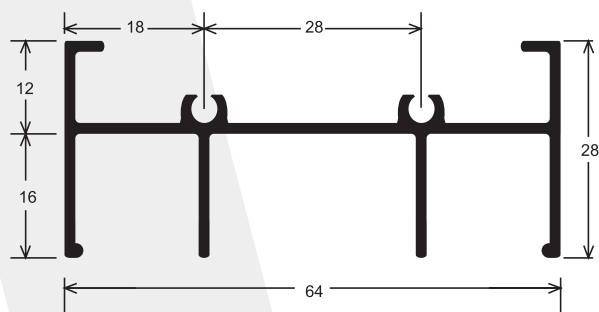
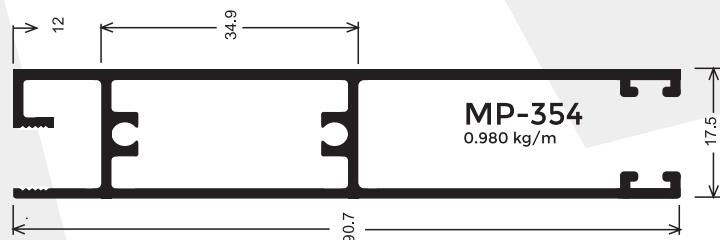
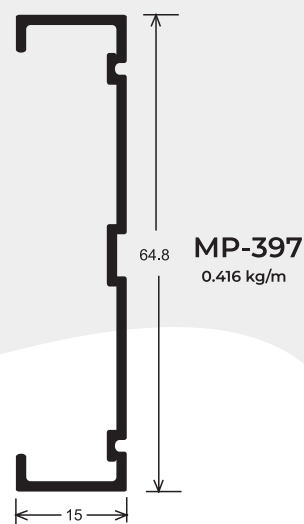
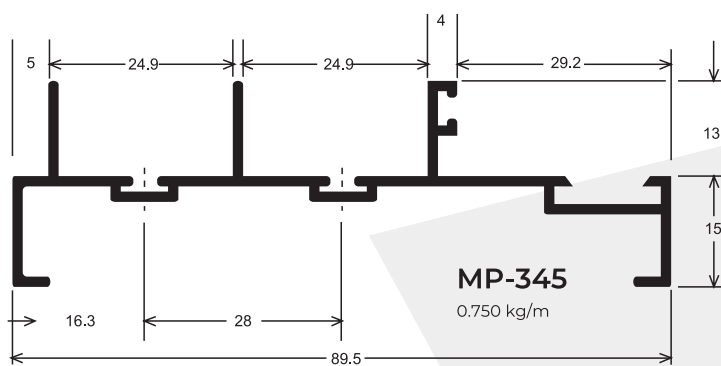
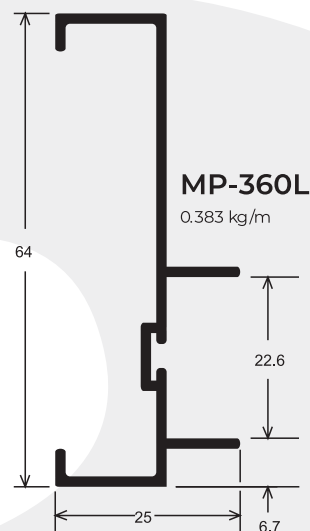
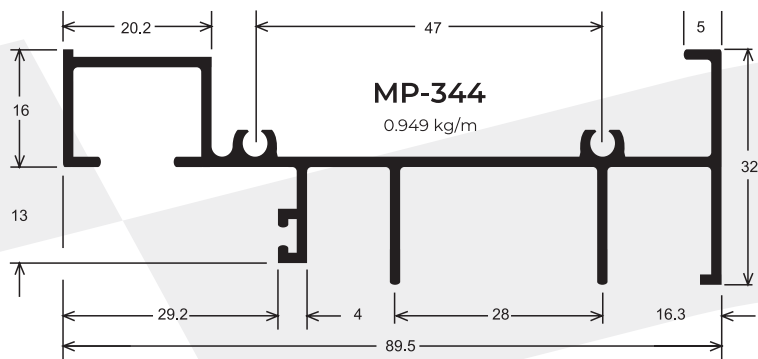

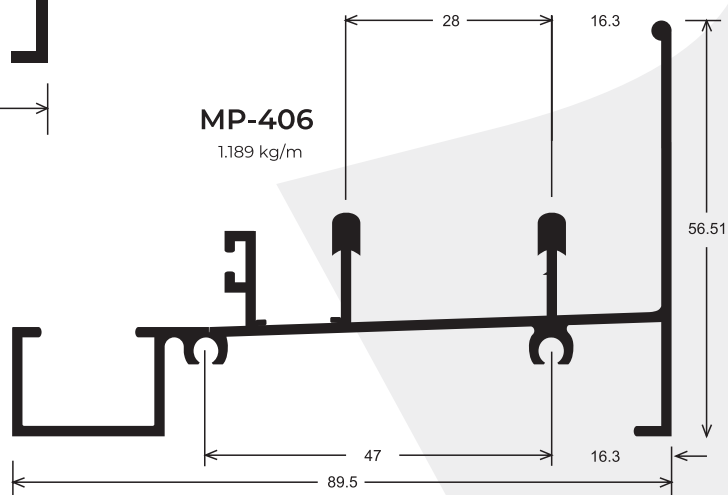
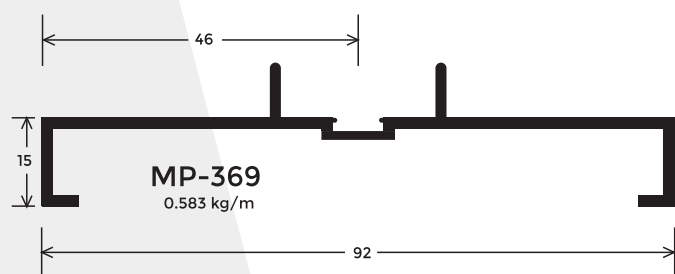
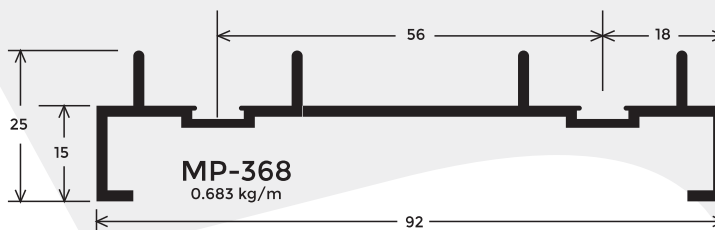
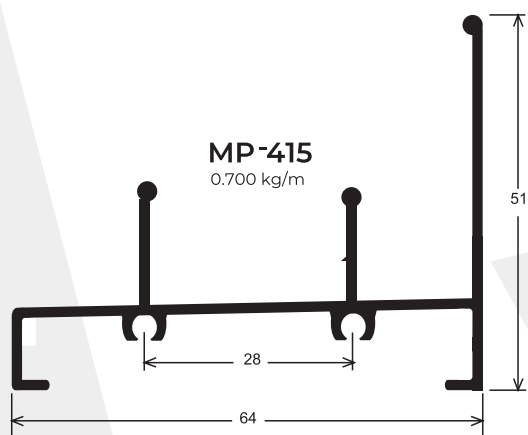
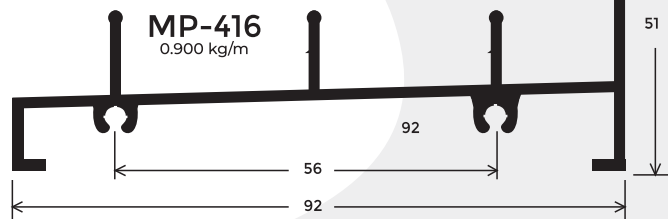
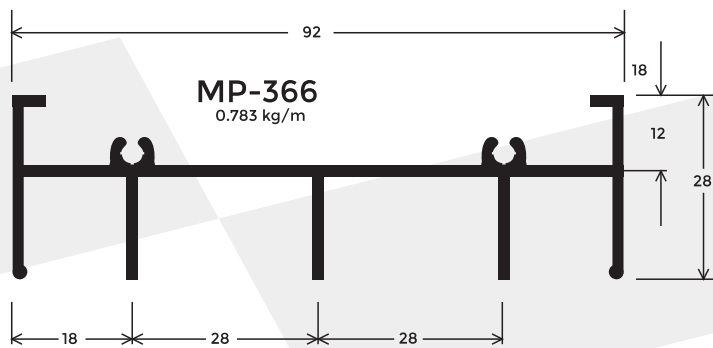

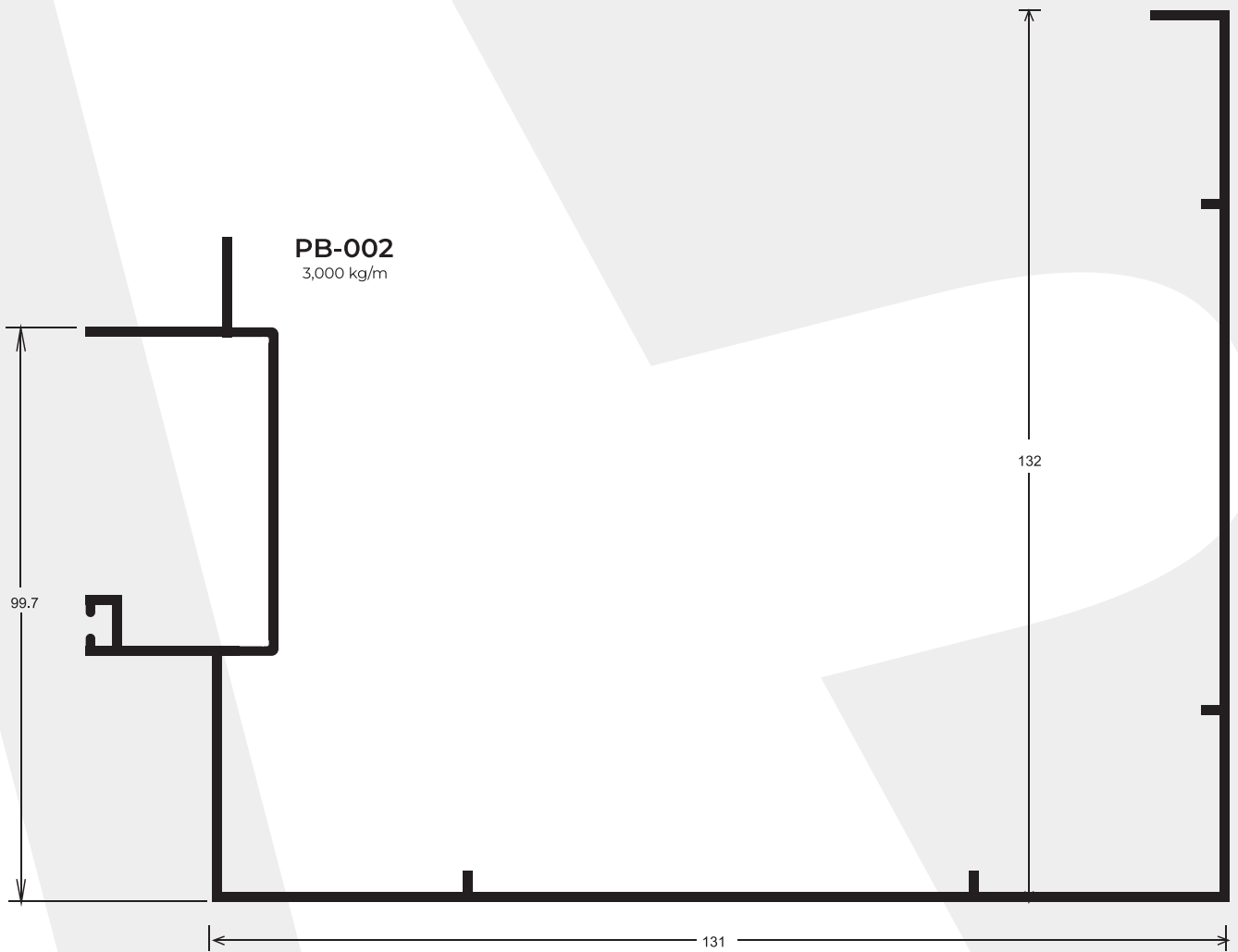
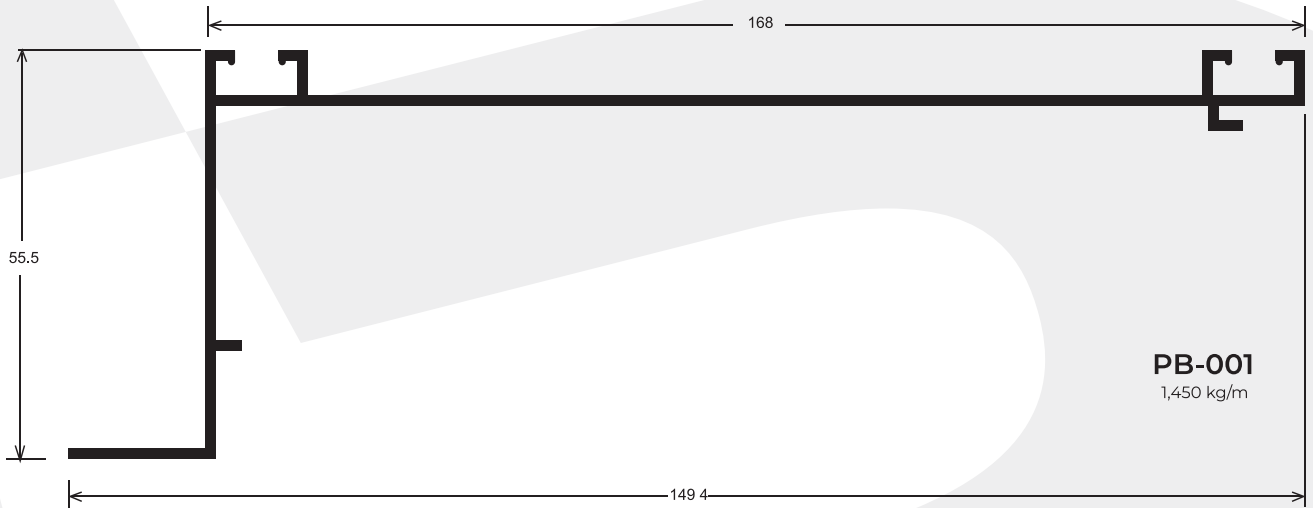

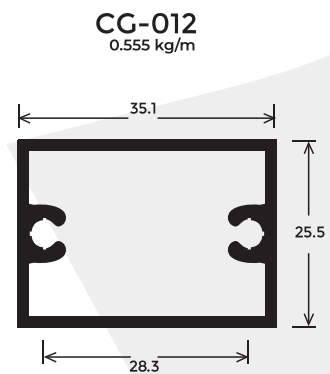
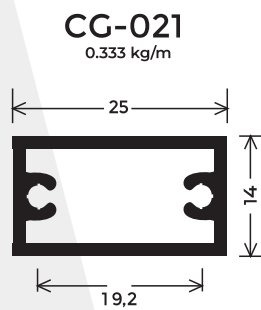
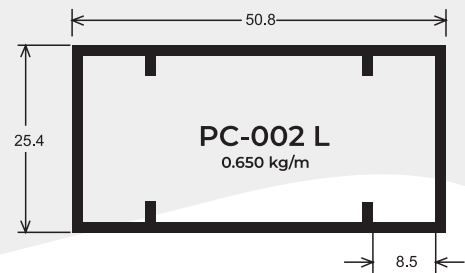
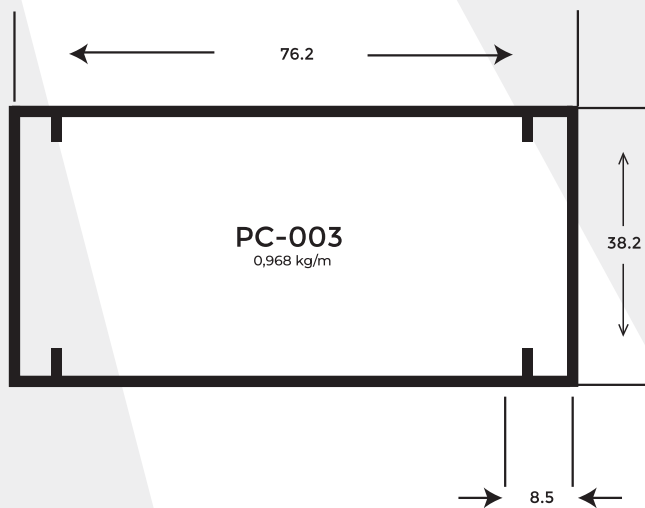
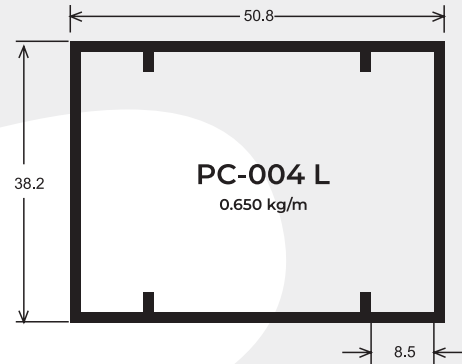
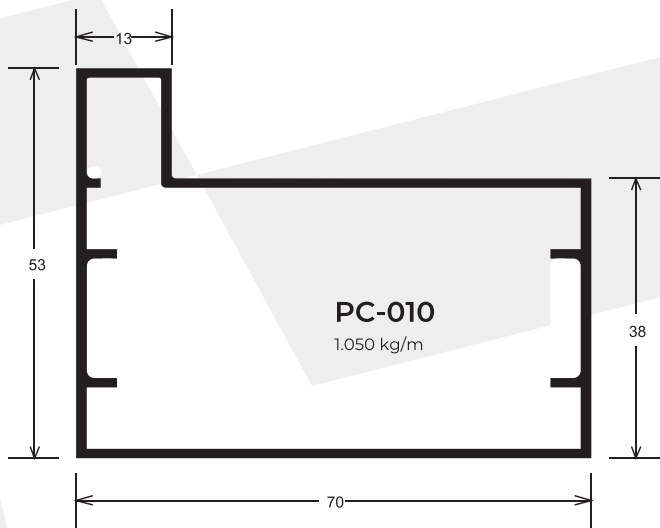

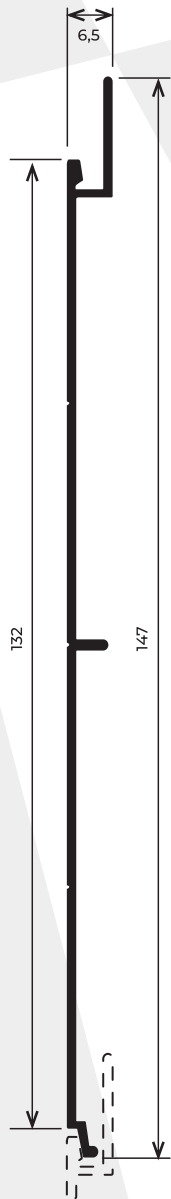

**WLB-036**  
0.616 kg/m

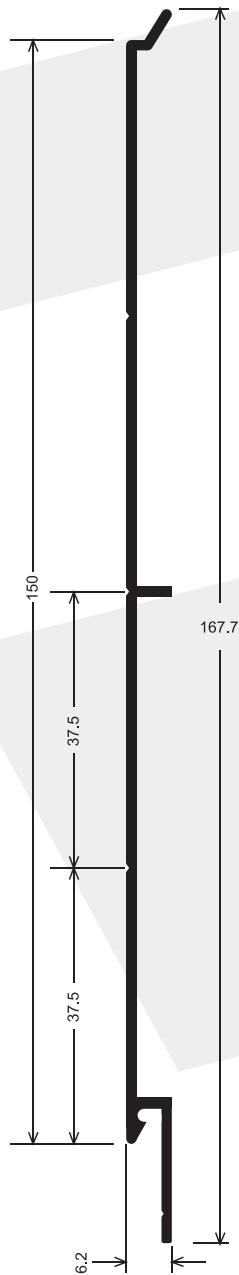

**LB-036**  
0.791 kg/m

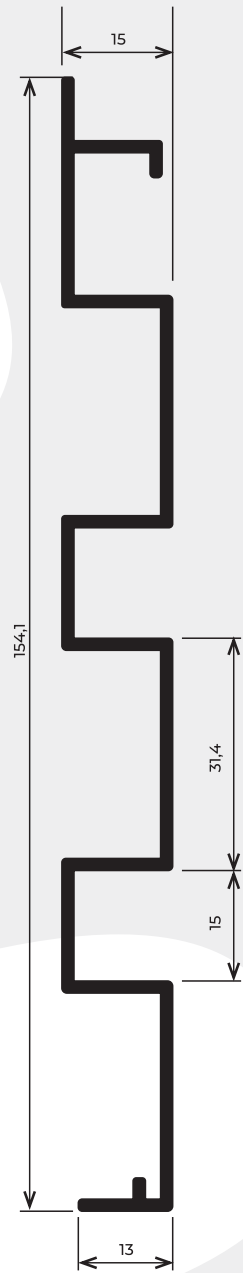

**LB-075**  
1,038 kg/m

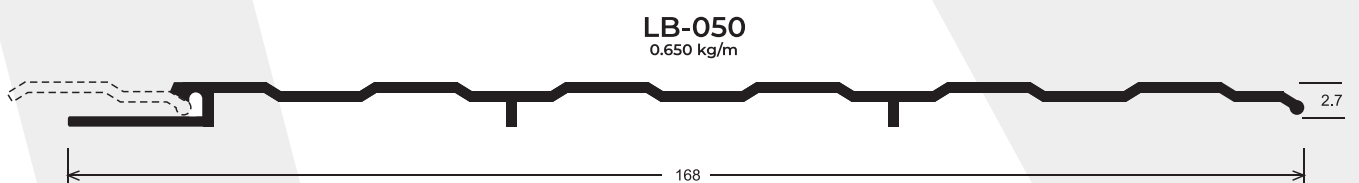

**LB-050**  
0.650 kg/m

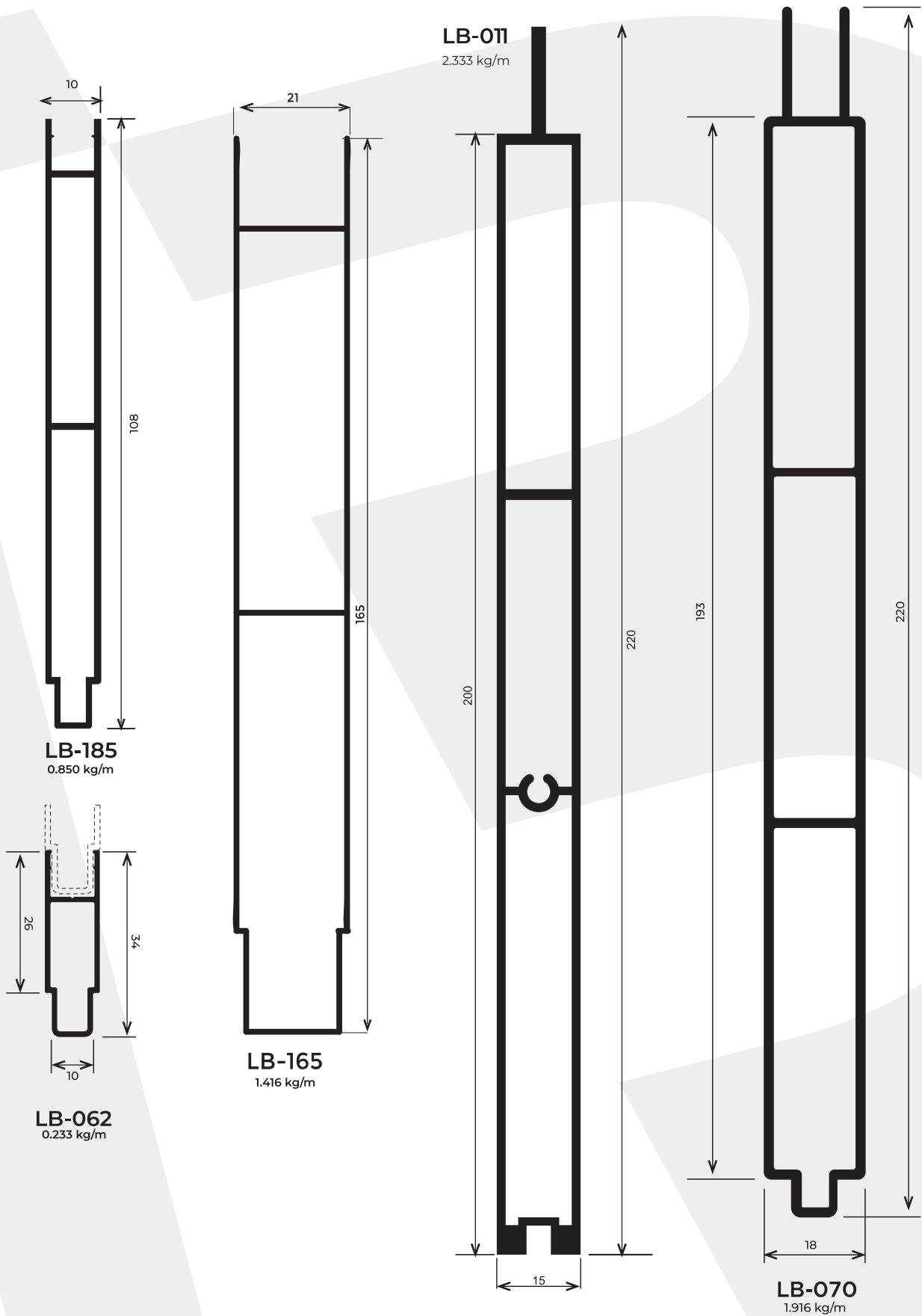





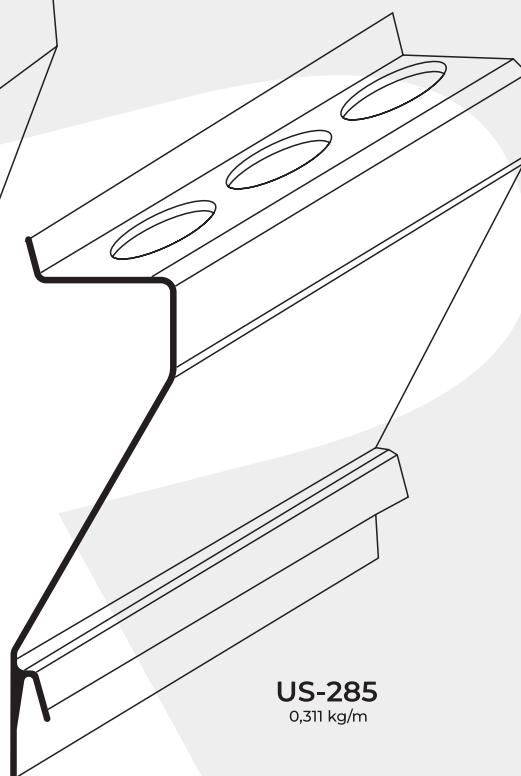
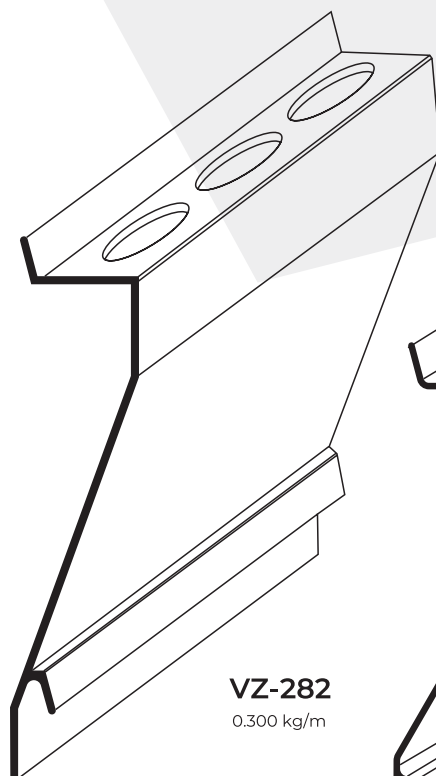
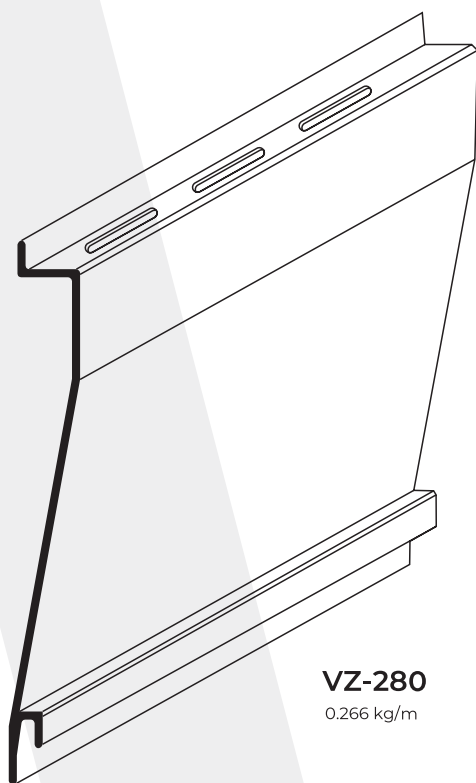
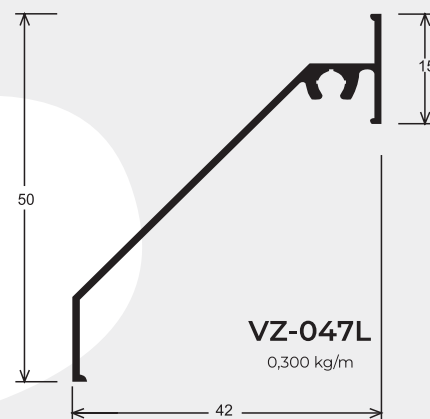
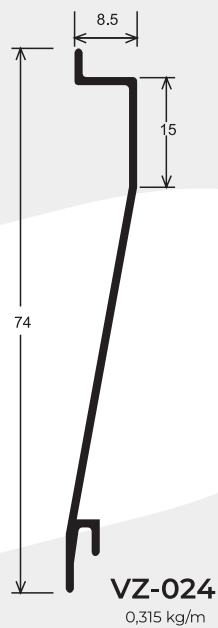
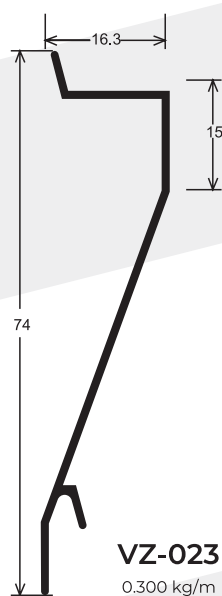
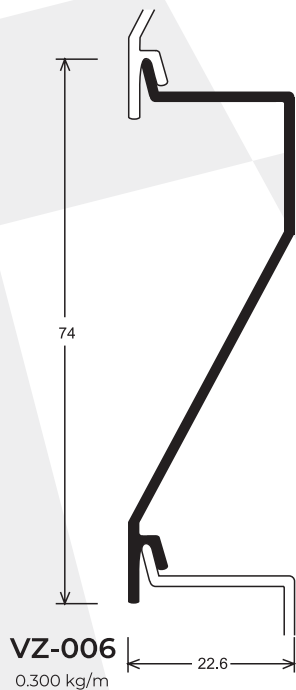

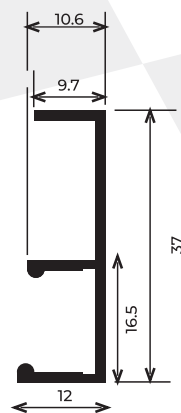

**MP-347**

0.202 kg/m

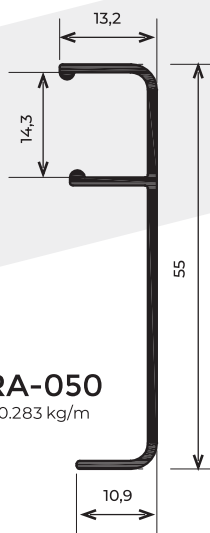

**RA-050**

0.283 kg/m



**RA-052**

0.300 kg/m

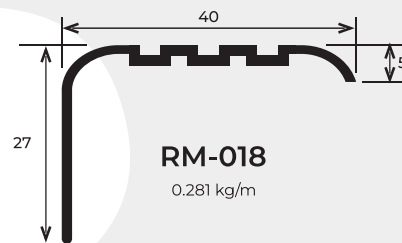

**RM-018**

0.281 kg/m

## LINHA CONTRAMARCO

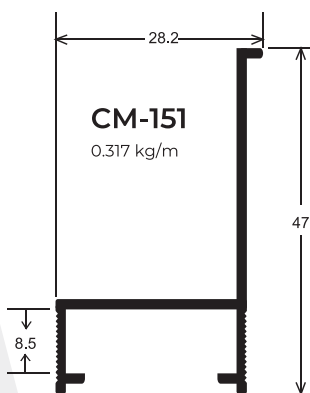

**CM-151**

0.317 kg/m

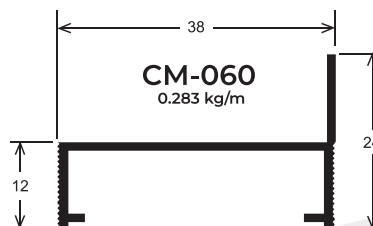

**CM-060**

0.283 kg/m

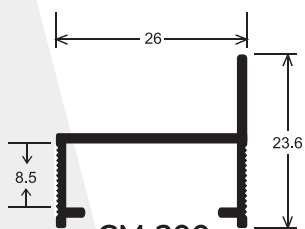

**CM-200**

0.205 kg/m

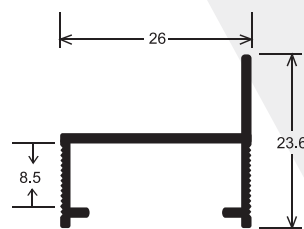

**CM-204**

0.185 kg/m

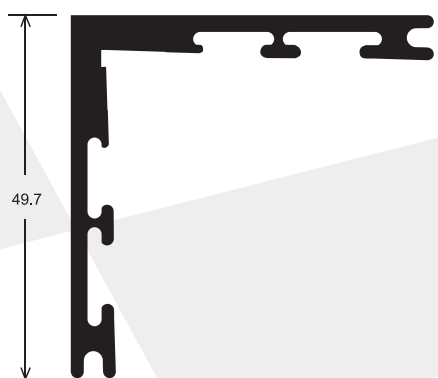

**CL-006**  
1.136 kg/m

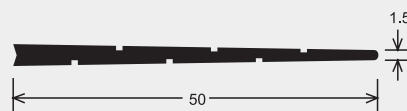

**CL-011**  
0.333 kg/m

## CUNHA E CANTONEIRAS CORTADA

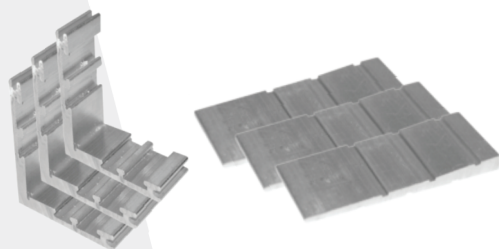

**CL-025**  
LINHA 25

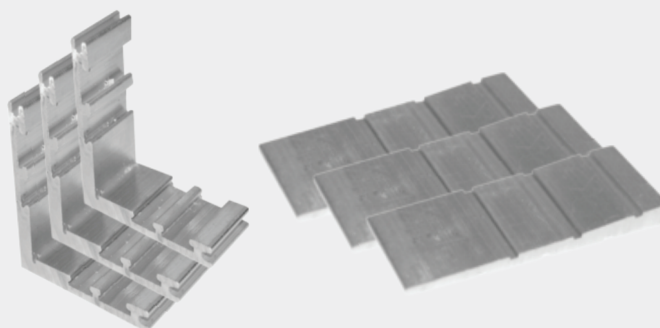

**CL-030**  
LINHA 30

## POLICARBONATO

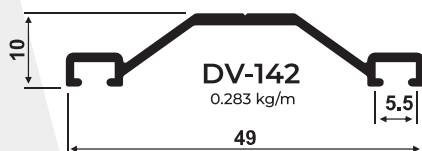

**DV-142**  
0.283 kg/m

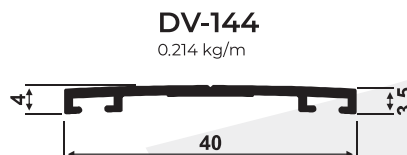

**DV-144**  
0.214 kg/m



**POLIH**

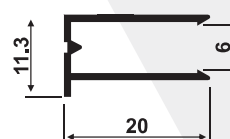

**DV-143**  
0.141 kg/m

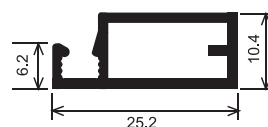
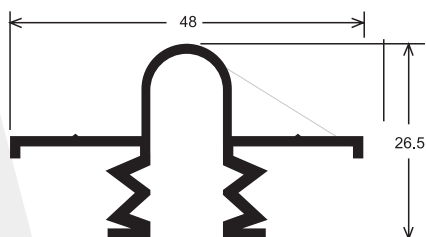
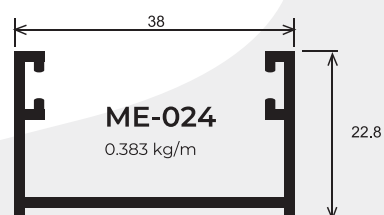
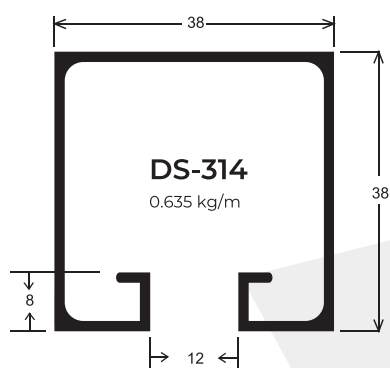

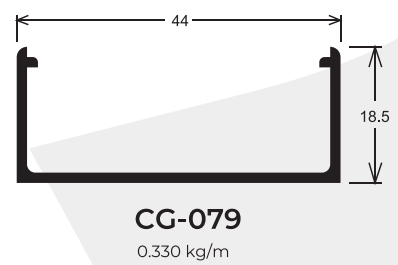
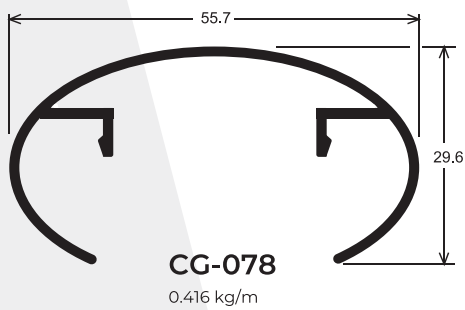
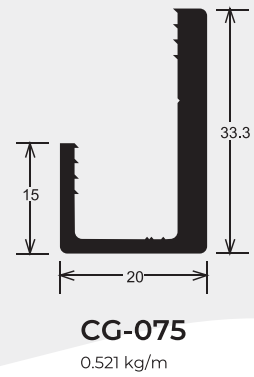
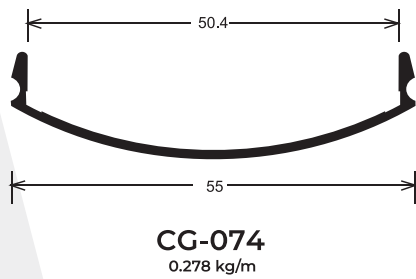
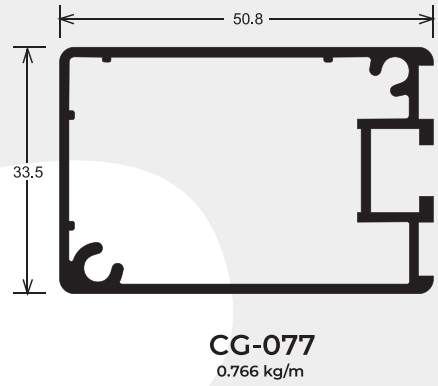
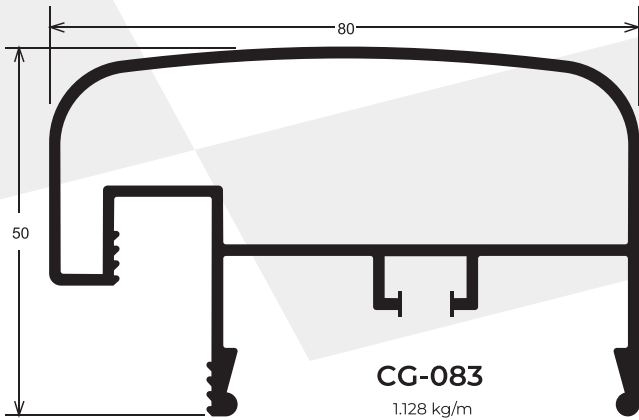

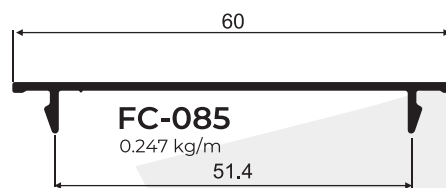
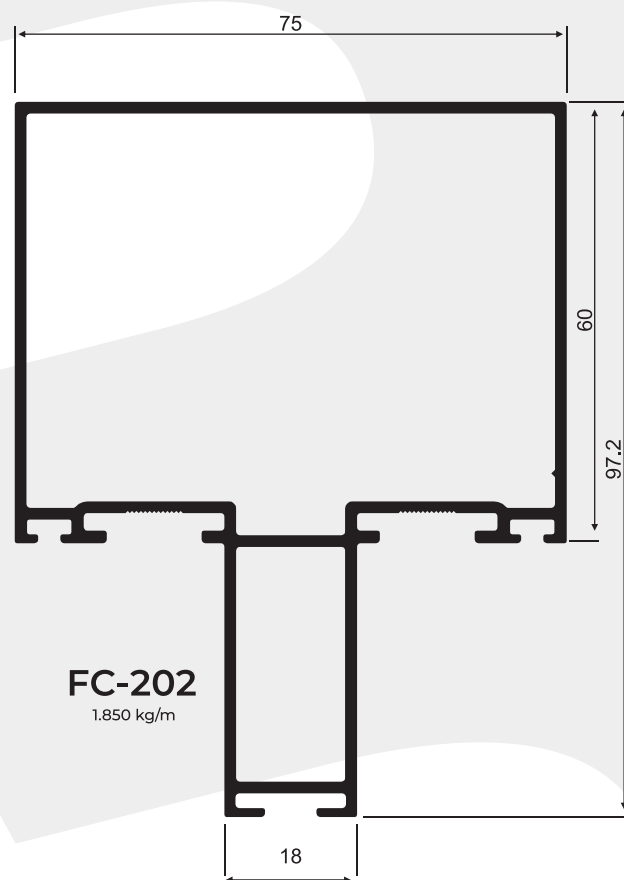
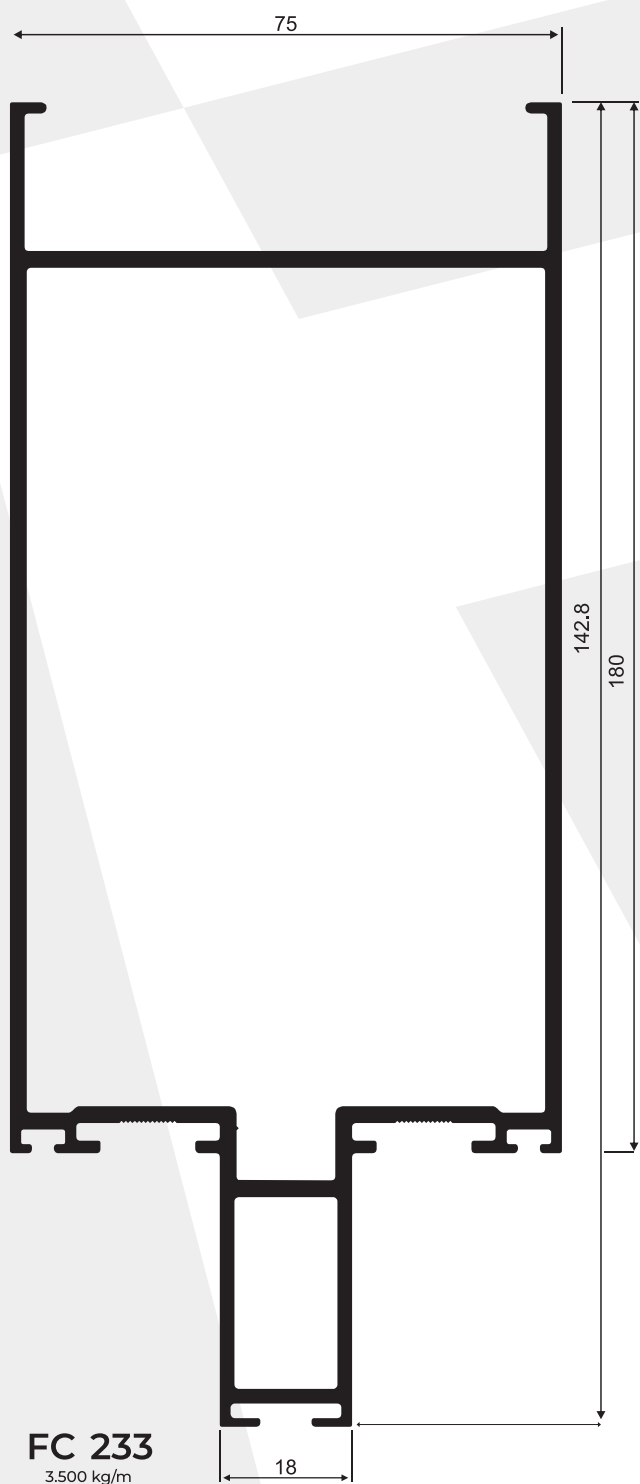

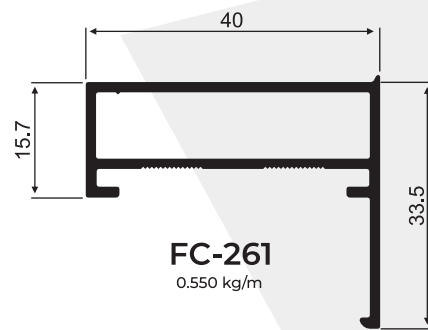
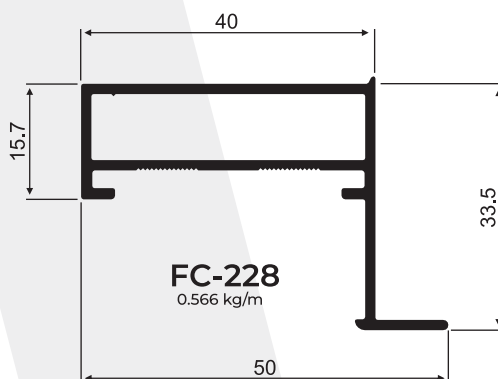
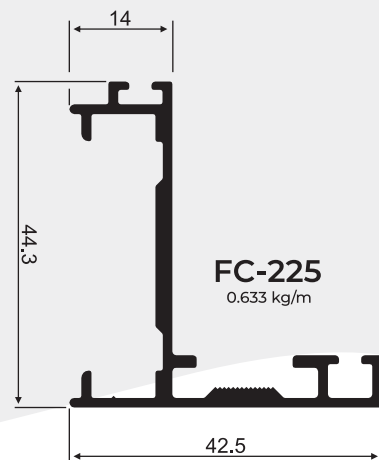
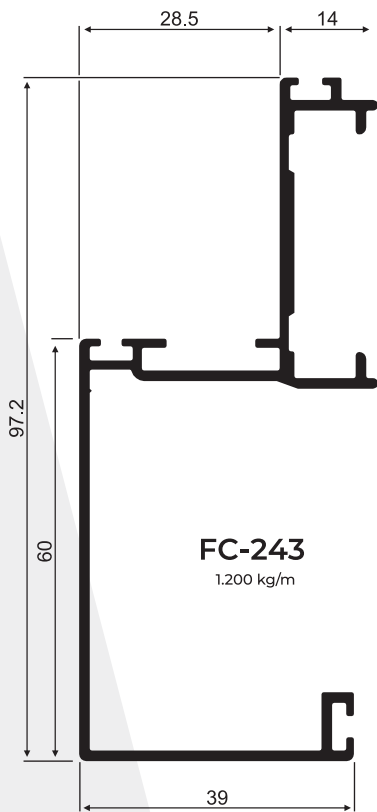
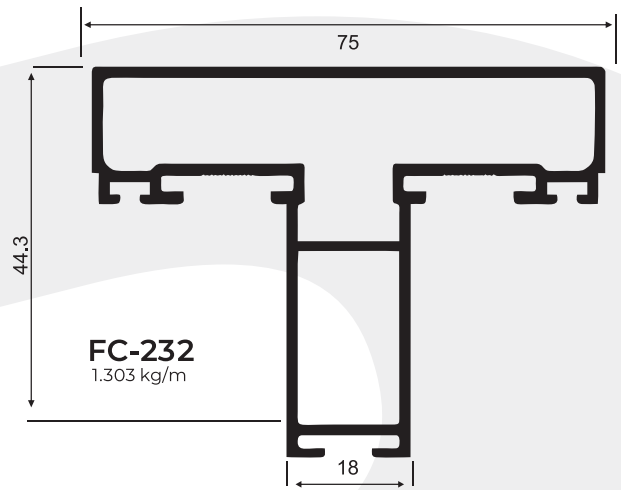
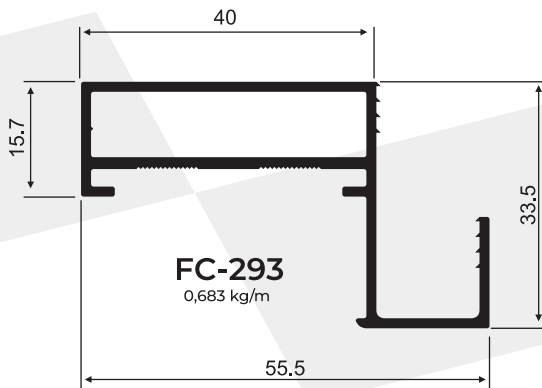

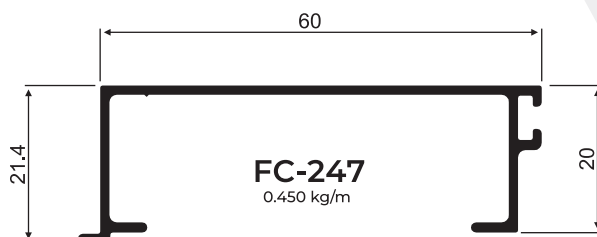
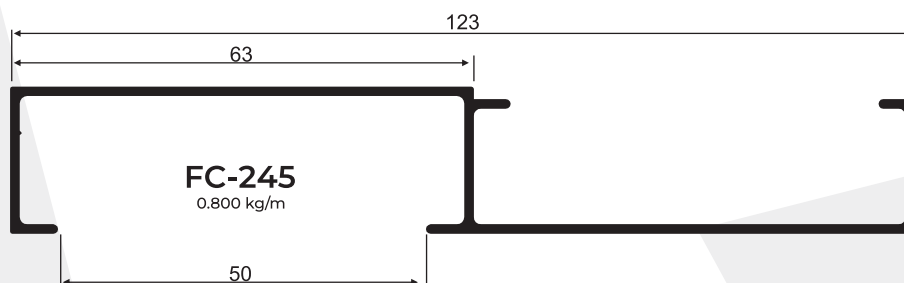
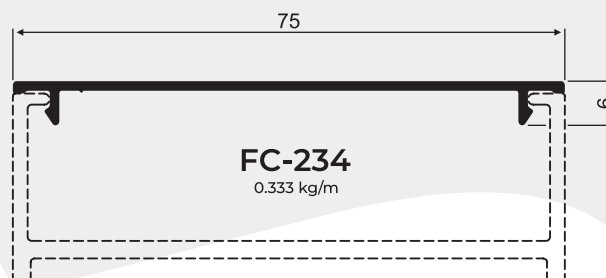
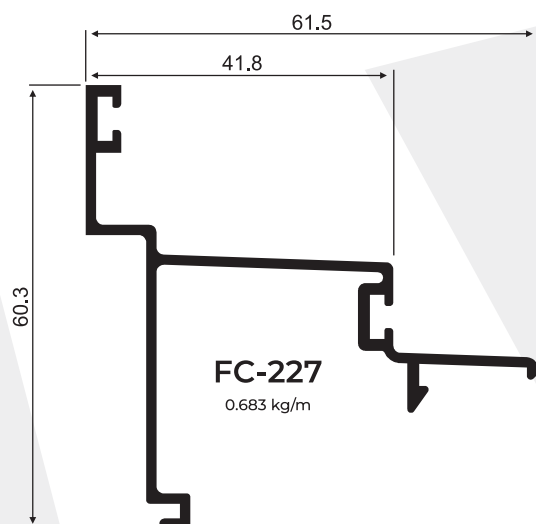
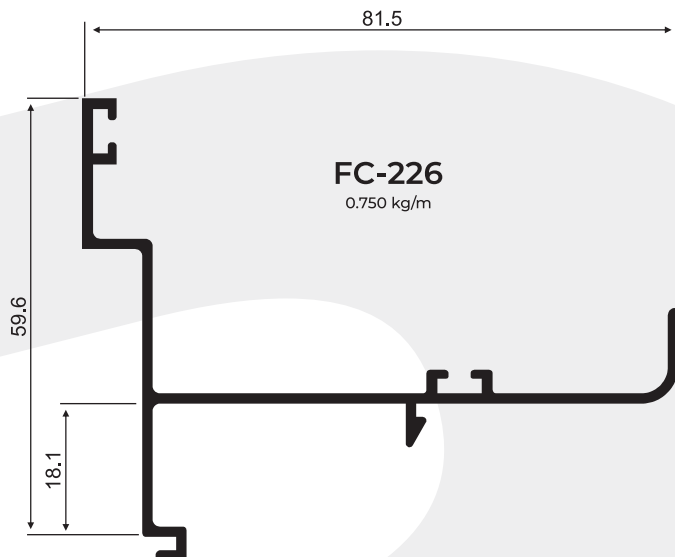
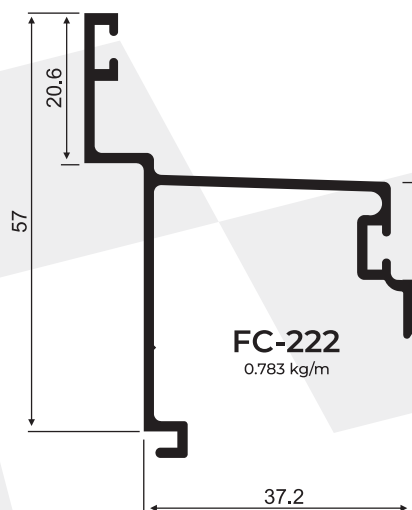



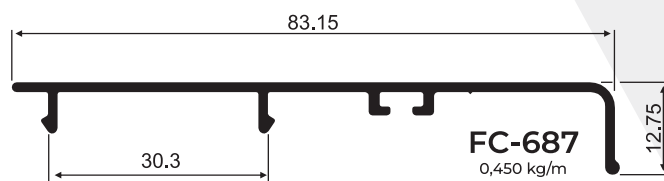
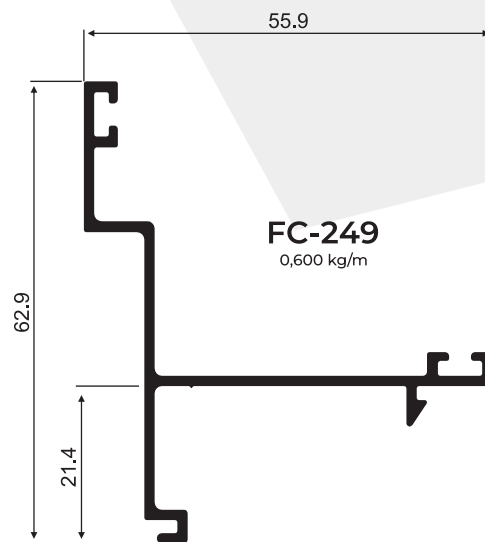
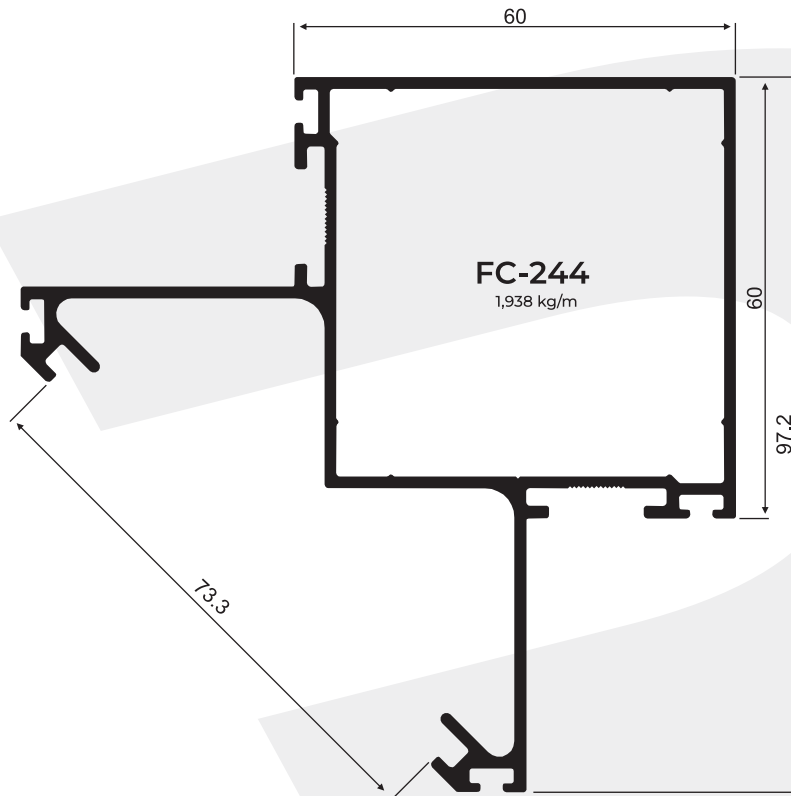

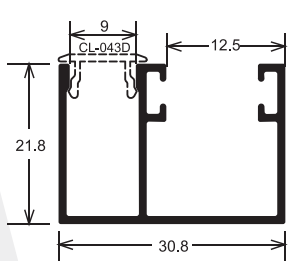
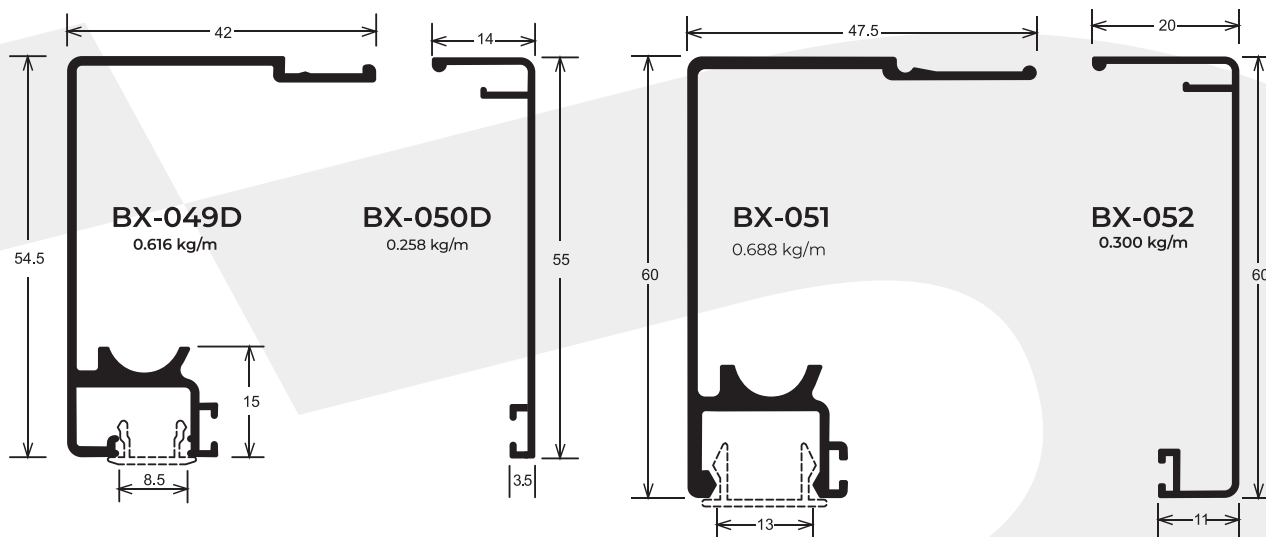

**BX-075**  
0.333 kg/m

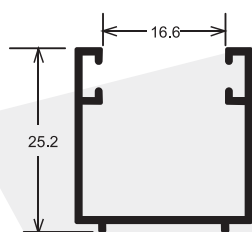

**BX-069**  
0.300 kg/m

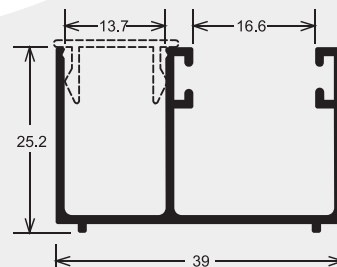

**BX-240**  
0.433 kg/m

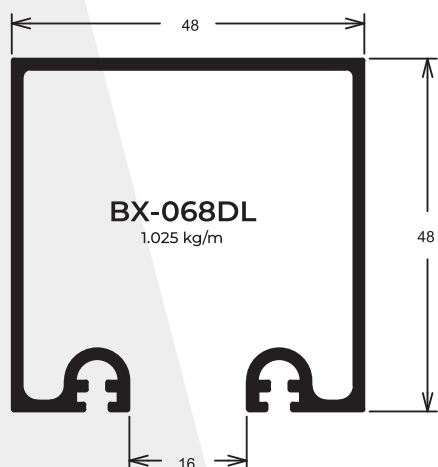

**BX-068DL**  
1.025 kg/m

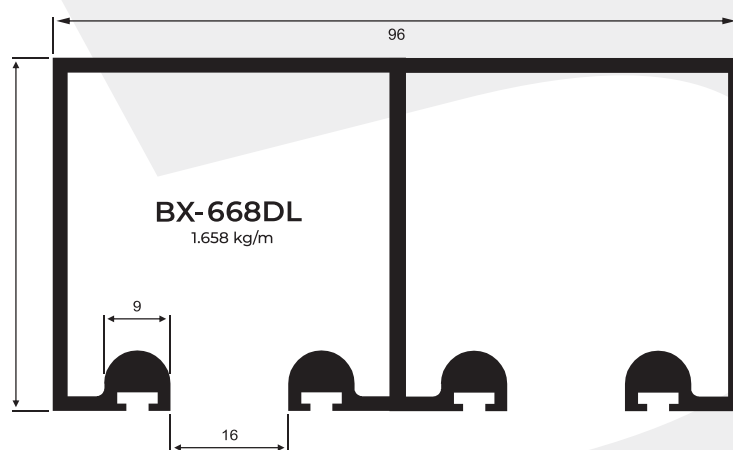

**BX-668DL**  
1.658 kg/m

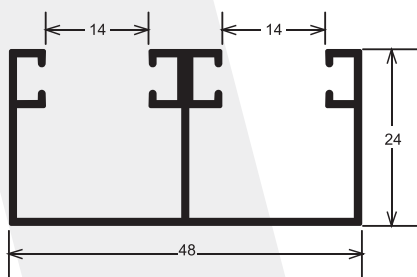

**BX-170**  
0.540 kg/m

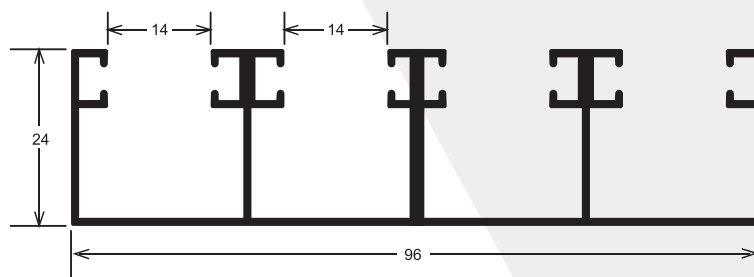

**BX-172**  
1.040 kg/m

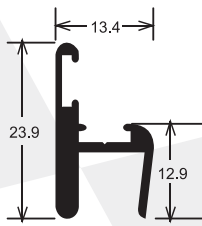

**CB-266**  
0.266 kg/m

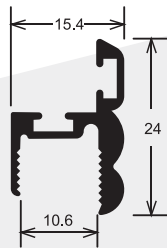

**BX-209**  
0.266 kg/m

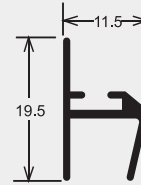

**BX-130**  
0.131 kg/m

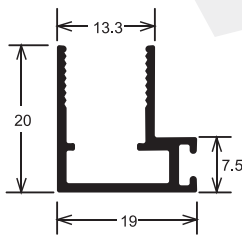

**BX-241**  
0.241 kg/m

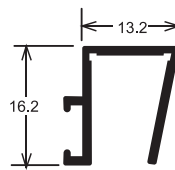

**CB-275**  
0.165 kg/m

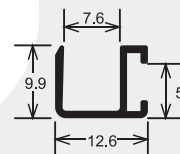

**BX-126**  
0.100 kg/m

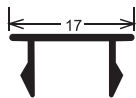

**CL-022**  
0.100 kg/m



**CL-043D**  
0.066 kg/m

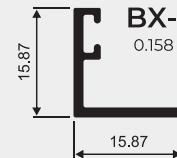

**BX-229**  
0.158 kg/m

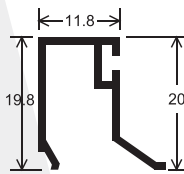

**BT-030**  
0.183 kg/m

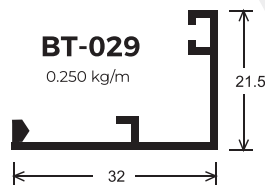

**BT-029**  
0.250 kg/m

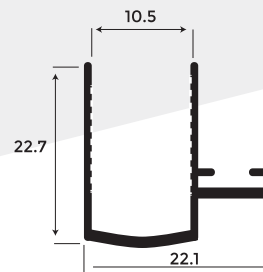

**PBT-037**  
0.233kg/m

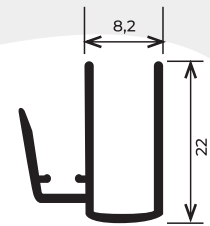

**PBT-040**  
0.193 kg/m

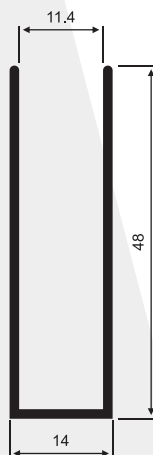

**PU-071**  
0.393 kg/m

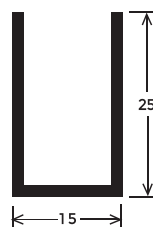

**PU-344**  
0.217 kg/m

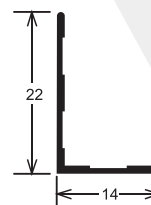

**BX-137**  
0.161 kg/m

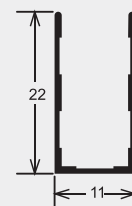

**BX-103**  
0.133 kg/m

**BX-153**

0.216 kg/m

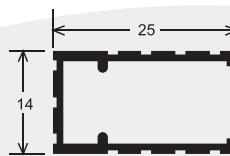
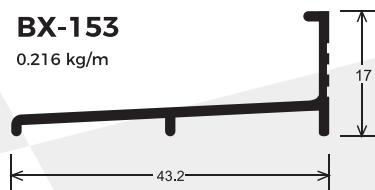

**BX-158L**

0.200 kg/m

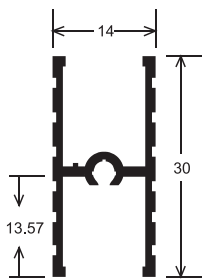

**BX-159**

0.268 kg/m

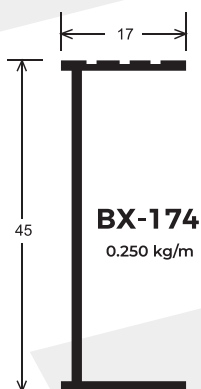

**BX-174**

0.250 kg/m

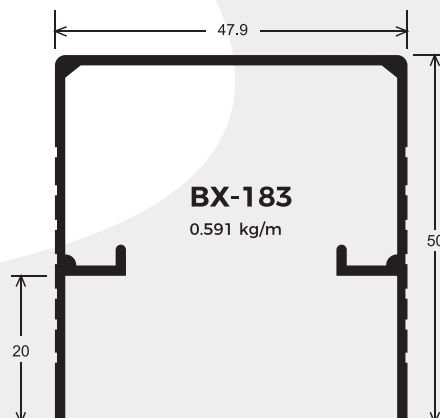

**BX-183**

0.591 kg/m

# LINHA SOROBX



**BX-174D**

0.250 kg/m

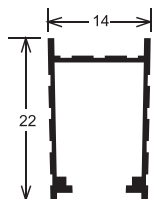

**BX-158D**

0.150 kg/m

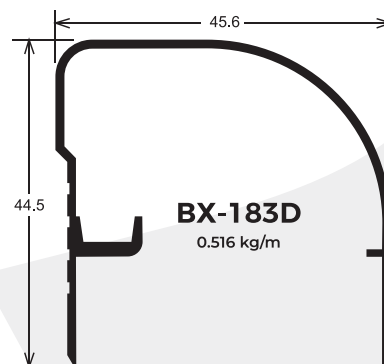

**BX-183D**

0.516 kg/m

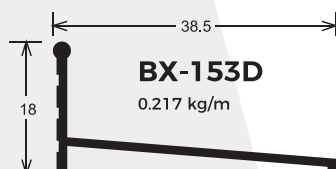

**BX-153D**

0.217 kg/m

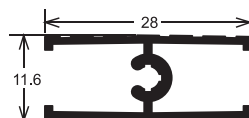

**BX-159D**

0.217 kg/m

Temos também chapas de acrílico, guarnição e componentes.

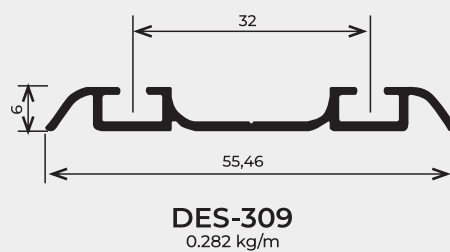
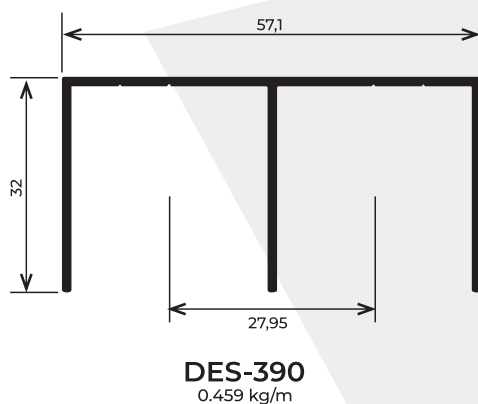
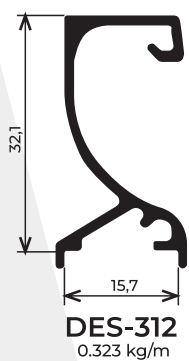
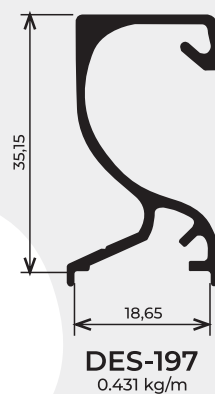
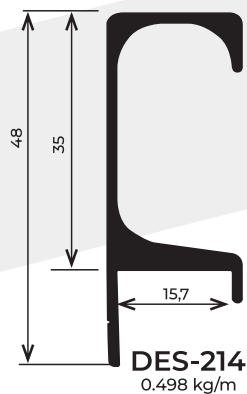
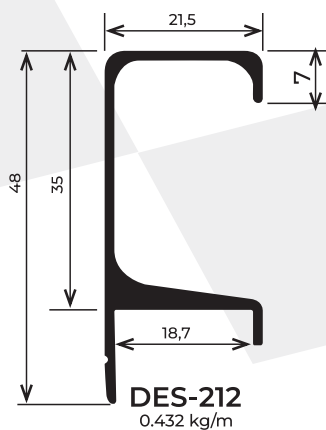

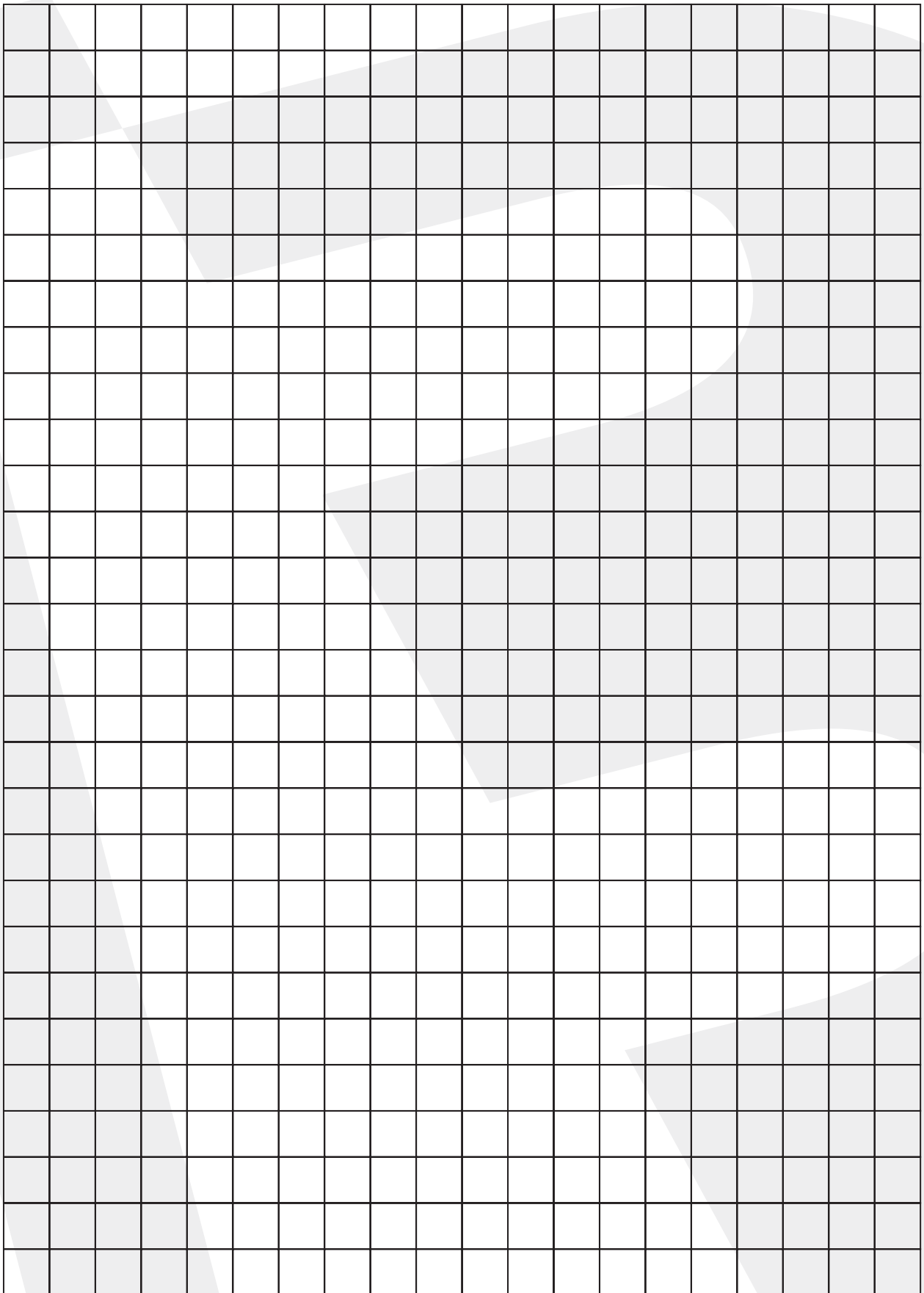

## CONCHA CEGA

138mm



DIVERSAS  
CON-277

## FECHO CONCHA FECHAMENTO LATERAL

138mm



SUPREMA  
FEC-250

## FECHO CONCHA COM TRAVA AUTOMÁTICO E MANUAL

138mm



DIVERSAS  
FEC-636

## FECHO CARACOL



SUPREMA  
FEC-947

## FECHO CARACOL



MP, ME  
FEC-966

## FECHO CARACOL



SUPREMA  
FEC-060

## CORRER MULTIPONTO



SUPREMA, MEGA 25  
KMC-05 (600mm)  
KMC-06 (1000mm)

## FECHO TIPO CAMARÃO DE EMBUTIR

Excelência



EXCELÊNCIA  
FEC-696

## FECHO UNHA DE EMBURIR

HASTE NÃO ACOMPANHA (VR-002)



SUPREMA, MP  
FEC-609

FECHO TIPO CAMARÃO  
DE EMBUTIR



MP, ME  
FEC-695

CONTRATESTA



SUPREMA  
CON-250

CONTRAFECHO LATERAL

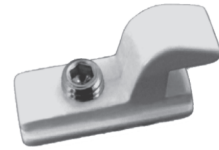

SUPREMA  
CON-370

ROLDANA COM REGULAGEM  
E COM ROLAMENTO

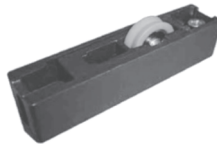

SUPREMA, MEGA 25  
ROL-440

ROLDANA DUPLA COM  
REGULAGEM E COM  
ROLAMENTO

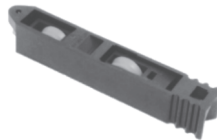

SUPREMA, MEGA 25  
ROL-439

ROLDANA SEM REGULAGEM  
SEM ROLAMENTO



MÓDULO PRÁTICO  
ROL-237

ROLDANA COM REGULAGEM  
COM ROLAMENTO

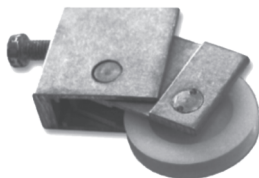

MÓDULO PRÁTICO  
ROL-415R

ROLDANA DUPLA CANAL  
RETO COM ROLAMENTO



DIVERSAS  
ROL-294

ROLDANA DUPLA CANAL  
CÔNCAVO COM ROLAMENTO



DIVERSAS  
ROL-299



ROLDANA COM REGULAGEM  
SEM ROLAMENTO

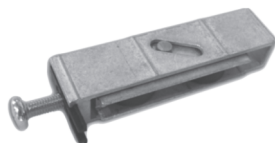

MÓDULO ESPECIAL

ROL-412

ROLDANA ZAMAK  
PARA PORTÃO DE CORRER



DIVERSAS

ROL-206

ROLDANA DE NYLON  
PARA PORTÃO DE CORRER

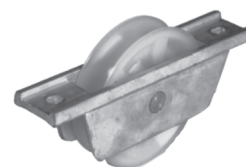

DIVERSAS

ROL-207

DOBRADIÇA PARA PORTA DE  
GIRO



DIVERSAS

DOB-736 50X40X1.5  
DOB-740 70X60X2.2  
DOB-745 90X70X2.4

DOBRADIÇA TIPO CAMARÃO

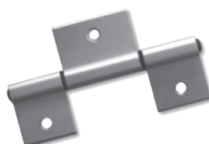

MP

DOB831 - S/ PUX  
DOB832 - C/ PUX

DOBRADIÇA TIPO CAMARÃO



SUPREMA

DOB837 - S/ PUX  
DOB838 - C/ PUX

DOBRADIÇA PARA PORTA



SUPREMA

DOB-840

DOBRADIÇA PARA PORTA  
COM ABAS DESIGUAIS



CONVENCIONAL 25

DOB-692

DOBRADIÇA PARA PORTA



CONVENCIONAL 30

DOB-751

## ARTICULAÇÃO PARA MAXIM-AR



P.V. II

ARP-60 - 600MM  
ARP-95 - 950MM

## ARTICULAÇÃO PARA MAXIM-AR



MÓDULO MAX

BRA-632 - 250MM  
BRA-635 - 350MM  
BRA-638 - 550MM  
BRA-641 - 700MM

## ARTICULAÇÃO PARA MAXIM-AR



SUPREMA

BRA-705 - 250MM  
BRA-704 - 400MM  
BRA-702 - 500MM  
BRA-703 - 750MM  
BRA-725 - 810MM

## FECHO ALAVANCA



P.V. II

FEC-152 DIREITO  
FEC-155 ESQUERDO

## FECHO ALAVANCA COM BAGUETE



MÓDULO MAX

FEC-125

## FECHO ALAVANCA COM BAGUETE



SUPREMA

FEC-009

RECOLHEDOR EMBUTIR



PERSIANAS DE ENROLAR

REC-032 40MM 118MM  
REC-013 60MM 118MM

CINTA DE FIXAÇÃO EM  
AÇO MOLA



PERSIANAS DE ENROLAR

FIT-148

TRAVA DA PERSIANA  
JANELA INTEGRADA



TRV-010

TAMPA DA LATERAL  
JANELA



PARA SU-515  
TPA-250

TAMPA DA LATERAL  
PORTA



PARA SU-517  
TPA-350

TAMPA DA PERSIANA



PERSIANAS DE ENROLAR  
NYL-375

KIT MOTOR C/ CONTROLE



RECEPTOR INTEGRADA  
KIT-02

PALHETA JANELA INTEIRA

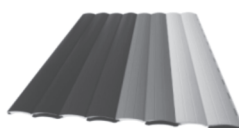

PERSIANAS DE ENROLAR  
VZP - VENTILADA  
VZC - CEGA

KIT MOTOR S/ CONTROLE



RECEPTOR INTEGRADA  
KIT-04

GUIA DA PERSIANA



DIVERSAS  
NYL-370

LIMITADOR DE ABERTURA

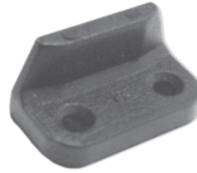

PERSIANAS DE ENROLAR  
NYL-378

GUIA PARA JANELAS E  
PORTAS DE CORRER



SUPREMA, ABSOLUTA,  
ALUK 2.5  
NYL-332 c/ placa  
NYL-332 s/ placa

PUXADOR CEGO  
160mm



DIVERSAS  
PUX-005

GUIA E LIMITADOR

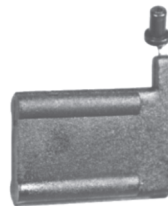

DIVERSAS  
NYL-369

DISCO ALINHADOR  
DE PERSIANA

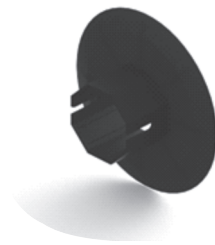

SUPREMA  
DIA40 - EIXO DE 40  
DIA60 - EIXO DE 60

GUIA DESLIZANTE  
P/ CAMARÃO D/E



SUPREMA  
NYL-400

GUIA DESLIZANTE P/  
CAMARÃO CENTRAL



LINHA MP  
NYL-401

ARTICULAÇÕES P/  
MAXIM - AR 340mm



BRA-762

ARTICULAÇÕES P/  
MAXIM - AR 600mm



BRA-763

ARTICULAÇÕES P/  
MAXIM - AR 950mm



BRA-764

CALÇO VEDANTE

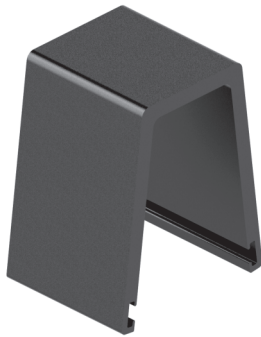

CAL-929

CALÇO VEDANTE

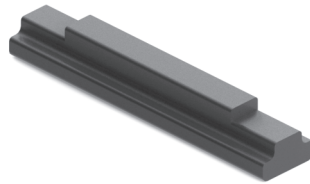

CAL-945

CONTRAFECHO DA  
FOLHA FIXA

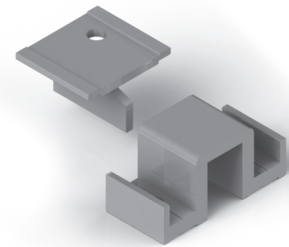

CON-32

CONCHA CEGA 180mm



CON-155

FECHO CONCHA C/FIXAÇÃO  
NÃO APARENTE



CON-320

FECHO CONCHA C/FIXAÇÃO  
NÃO APARENTE

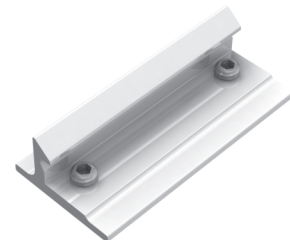

CON-321

VEDAÇÃO SUPERIOR

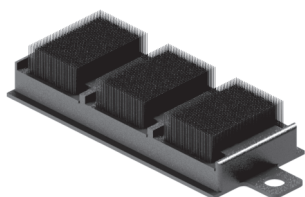

CON-381

CONTRAFECHO LATERAL

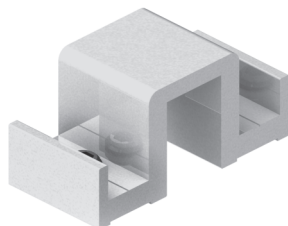

CON-383

CONTRAFECHO LATERAL  
4 FOLHAS

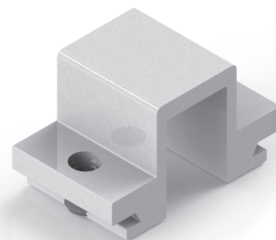

CON-385

FECHO CONCHA LATERAL



FEC-254

FECHO ALAVANCA  
SEM BAGUETE



FEC-493

FECHO CONCHA 204mm



FEC-104

TAMPA LATERAL P/JANELA



NYL-382

TAMPA LATERAL P/PORTA



NYL-383

CALÇO DA FOLHA FIXA

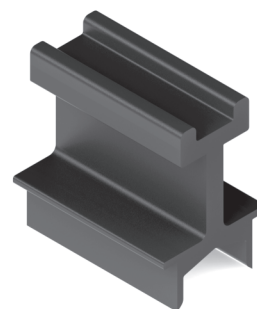

NYL-394

CAIXA DO DRENO

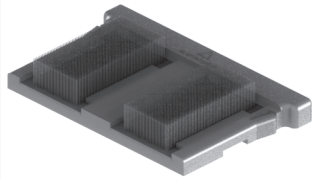

NYL-395

GUIA E LIMITADOR



NYL-396

BATEDEIRA



NYL-398

ROLDANA DUPLA COM REGULAGEM E ROLAMENTO

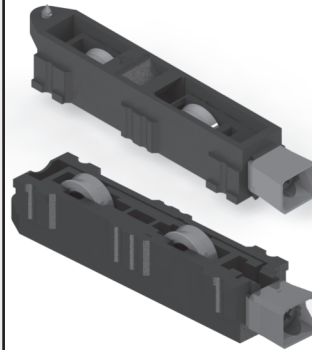

ROL-413

ROLDANA SIMPLES COM REGULAGEM E ROLAMENTO

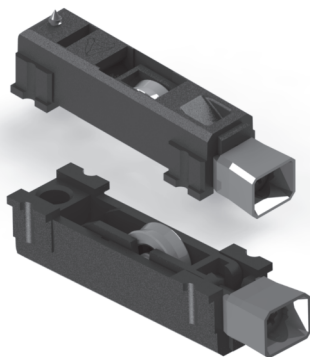

ROL-468

ROLDANA POWERFULL DUPLA C/REGULAGEM E ROLAMENTO

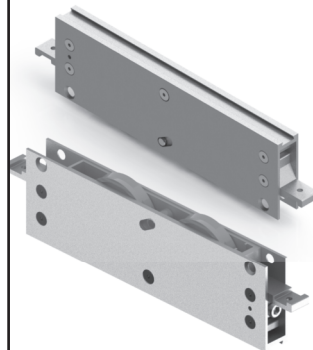

ROL-471

GUIA E PONTEIRA



SUPREMA, ABSOLUTA, ALUK  
NYL-336

GUIA DESLIZANTE

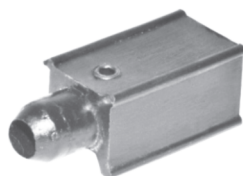

MP- ME  
NYL-304

TRAVA DE FECHO TIPO UNHA

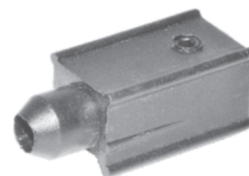

MP-ME  
NYL-303

GUIA DESLIZANTE COM FREIO



SUPREMA, ABSOLUTA, ALUK,  
CONVENCIONAL 25  
NYL-362

SUPORE DA GUIA



SUPREMA, ABSOLUTA, ALUK  
SUP-624

GUIA E LIMITADOR

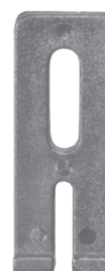

MP  
NYL-036

GUIA E LIMITADOR



SUPREMA, MEGA25,  
ABSOLUTA ALUK 2.5  
GUI-250

BATEDEIRA JANELA



SUPREMA  
NYL-414

TAMPA PARA ARREIMATE

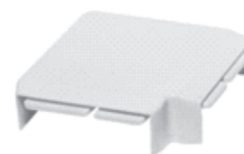

SUPREMA  
TAM347



TAMPA DO MONTANTE



SUPREMA, ABSOLUTA, ALUK  
2.5, HYDRO OFFICIAL

NYL-357

TAMPA DO MONTANTE  
(SU-504, SU-505)

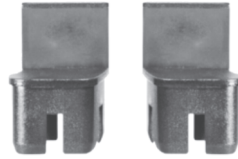

MEGA20, 25

TPA-255

BOTÃO TAPA FURO

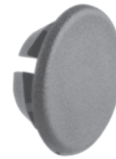

DIÂMETRO 3/8", DIÂMETRO 1/2"

NYL-042

PRESILHA DO ARREMATE

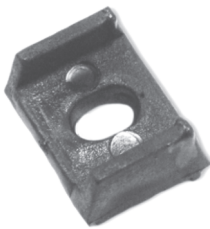

DIVERSAS

NYL-190

TAMPA DE RECOBRIMENTO



MP, ME, MÓDULO MAX

NYL-075

VEDAÇÃO SUPERIOR

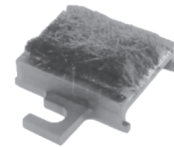

SUPREMA  
MEGA 25, ALUK 2.5

NYL-335

TAMPA PARA MAXIM-AR



ABSOLUTA, SUPREMA,  
ALUK 2.5

NYL-355

FIXADOR DE TRAVESSA



SUPREMA, ABSOLUTA,  
ALUK 2.5

CON-376

CAIXA DE DRENO

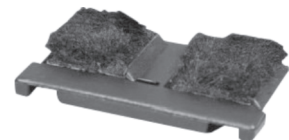

SUPREMA, 25

NYL-329

CANOPLA

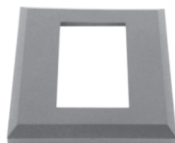

EXCELÊNCIA, GRADIL

CAN-206 - CG-012  
CAN-625 - CG-077

TAMPA CORRIMÃO



EXCELÊNCIA, GRADIL

TAM-083

SUPORTE DE FIXAÇÃO DO VIDRO

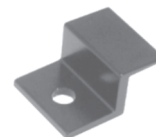

EXCELÊNCIA, GRADIL

SUP-626

SUPORTE DE FIXAÇÃO DO CORRIMÃO



EXCELÊNCIA, GRADIL

SUP-627

TAMPA DA PORCA SEXTAVADA 1/4"

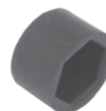

EXCELÊNCIA, GRADIL

NYL-314

CHUMBADOR PARA GRADIL



EXCELÊNCIA, GRADIL

CHU851 - 300MM P/ CG077  
CHU853 - 500MM P/ CG077  
CHU852 - 300MM P/CG012

SUPORTE DO CORRIMÃO



EXCELÊNCIA, GRADIL

SUP-980

CHUMBADOR



CM-060, CM-062, CM-098  
CM-151, CM-173, CM-174, CM-179  
CM-200, CM-204

CHU-840

CUNHA DO CONTRAMARCO



CM-060, CM-098

CON-060

CUNHA DO CONTRAMARCO



CM-102, CM-151, CM-200  
CM-063, CM-063, CM-204

CON-200

CONEXÃO DE NYLON  
PARA TELA MOSQUITEIRA



MOSQUITEIRA

CON-001

TRAVA TELA MOSQUITEIRA



MOSQUITEIRA

CON-002

TELA MOSQUITEIRA  
FIBRA DE VIDRO

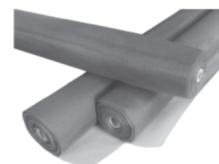

MOSQUITEIRA

GUA-002 - 1,5M ALTURA  
GUA-004 - 1,0M ALTURA

CONEXÃO EM ALUMÍNIO  
P/PC010



PORTÃO CONTRAPESO

CON-010

KIT PORTÃO CONTRAPESO



PORTÃO CONTRAPESO

KITPB

## FECHADURA TRIPLA ROLETE STAM



LINHA 30 PARA PORTAS  
FRA-1005/1007

## FECHADURA SIMPLES ROLETE STAM



LINHA 30 PARA PORTAS  
FRA-1002

## FECHADURA PORTA DE GIRO STAM



LINHA 25 PARA PORTAS  
FRA-602

## FECHADURA SIMPLES STAM



LINHA 25 PARA PORTAS  
FRA-601T (FECHADURA)  
FRA-601A (AUXILIAR)

## FECHADURA STAM BICO DE PAPAGAIO



LINHA 30 PARA PORTAS  
DE CORRER  
FRA-820

## TRANQUETA EM NYLON

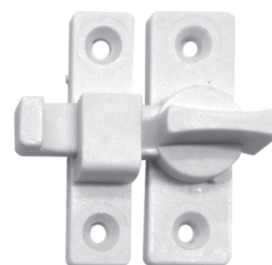

TRQ-260 - PRETO  
TRQ-261 - BRANCO

## PIVO STAM



PORTAS PIVOTANTES  
PIV-070

## FECHADURA LIVRE/OCUPADO



PORTAS  
FRA-034

## FERROLHO

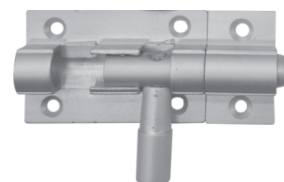

FER-104

ROLDANA COM CAV.  
FIXO PARA BOX

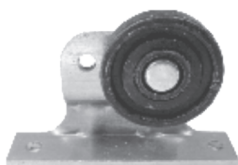

BOX  
ROL-260

ROOLDANA COM CAV.  
FIXO PARA SOROBOX

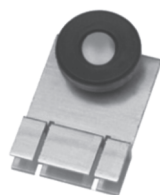

SOROBOX  
ROL-350

PUXADOR DE NYLON



BOX, SOROBOX  
PUX-154 - DUPLO  
PUX-153 - SIMPLES

SUPORE P/ TOALHA



BOX, SOROBOX  
NYL-315

FIXADOR INFERIOR  
DA FOLHA



BOX, SOROBOX  
NYL-327

GUIA DESLIZANTE  
INFERIOR DE NYLON



BOX, SOROBOX  
NYL-328

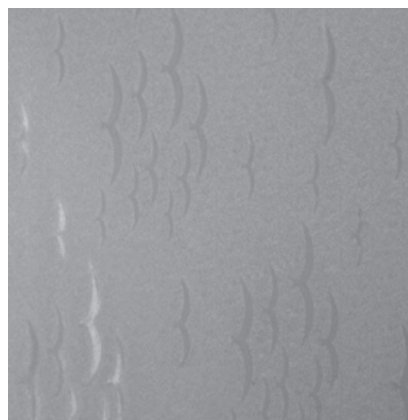

REVOADA  
CRISTAL E FUMÊ



AMAZONAS  
CRISTAL E FUMÊ



PANTANAL  
CRISTAL E FUMÊ



MONOCRIL  
CRISTAL E FUMÊ

ANCORAGEM SUPERIOR  
E INFERIOR

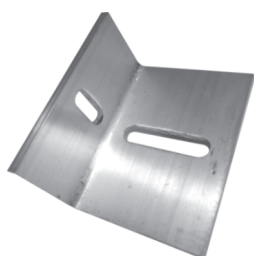

ANC-069

ANCORAGEM PARA  
COLUNA DE CANTO



ANC-059

PRESILHA DA FOLHA FIXA



PRE-060

PRESILHA DA COLUNA



PRE-070

ANCORAGEM



ANC-019

LUVA PARA COLUNA



LUV059

**ROLDANA PARA PORTA DE CORRER (ROLAMENTO IMPORTADO)**

Aço Zincado  
Rolamento Blindado

1125

**ROLDANA EXCÊNTRICA PARA BOX (ROLAMENTO IMPORTADO)**

Latão  
Rolamento Blindado

1125 E

**ROLDANA EXCÊNTRICA INJETADA (ROLAMENTO IMPORTADO)**

Nylon  
Rolamento Blindado

1125 EP

**ROLDANA DUPLA C/ REGULAGEM**

1125CR

**ROLDANA DUPLA C/ BALANCIM**

1125D

**ROLDANA PARA BOX SANFONADO**

ROLAMENTO BLINDADO  
Alumínio

1125 SF

**ROLDANA DUPLA 2 FUROS PARA 1030 (PORTAS ATÉ 80KG)**

Poliacetal  
Rolamento Blindado  
Alumínio  
Latão

1122

**ROLDANA SIMPLES 1 FURO PARA PORTA 1030 (PORTAS ATÉ 30KG)**

Poliacetal  
Rolamento Blindado  
Alumínio  
Latão

1122 S

**MINI CARRINHO SIMPLES 1 FURO PARA PORTA 1030 (PORTAS ATÉ 20KG)**

Poliacetal  
Rolamento Blindado  
Alumínio  
Latão

1122 M



**ROLDANA SIMPLES 1 FURO  
(PORTAS ATÉ 20KG)**

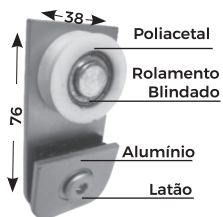

1120 A

**ROLDANA QUADRUPLA**



1150

**ROLDANA DUPLA**



1150S

**PARAFUSO COM  
PORCA DE LATÃO**



1005

**PARAFUSO PARA SISTEMAS  
"SÓ VIDROS"**



1006

**BOTÃO DE ACABAMENTO  
AVULSO PARA  
PUXADOR 1676S**



1010

**PARAFUSO PARA FIXAÇÃO  
DE ESPELHO**

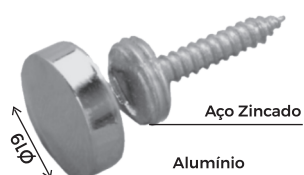

1090

**PIVOT SUPERIOR 1009  
(AÇO INOX)**

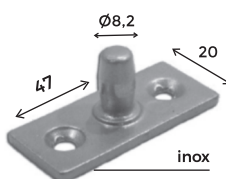

1009

**PIVOT INFERIOR 1014  
(AÇO INOX)**

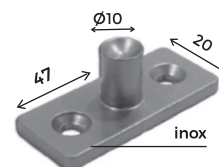

1014

**FECHADURA BICO DE PAPAGAIO COM PINO TRAVA PARA PORTA DE CORRER (RECORTE)**

1510

**CONTRA FECHADURA COM ABA DE PROTEÇÃO PARA 1510**

1511 P

**BATEDEIRA DE PAREDE PARA 1510**

1511 PA

**FECHADURA PARA PORTA DE CORRER FURAÇÃO BLINDEX 3530**

1510 X

**CONTRA FECHADURA 3530 PARA PORTA DE CORRER PARA 1510 X**

1511 X

**BATEDEIRA 3530 EM ALVENARIA PARA 1510 X / 1520 X**

1511 AX

**CONTRA FECHADURA 3530 90° PARA 1510X**

1511XG

**CONTRA FECHADURA 3530 90° PARA 1510X ALTA FURAÇÃO**

1511XGA

**FECHADURA PARA PORTA DE CORRER FURAÇÃO BLINDEX 3530**

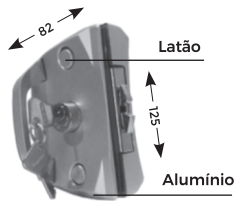

1510 BX

**CONTRA FECHADURA PARA PORTA DE CORRER FURAÇÃO BLINDEX 1510BX**

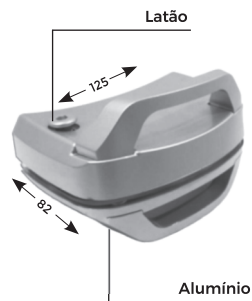

1511 BX

**BATEDEIRA EM ALVENARIA PARA 1510 BX**

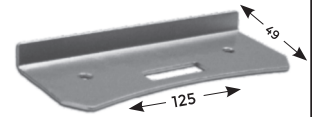

1511

**FECHADURA 3530 PARA PORTA DE CORRER COM RECORTE P/ CADEIRINHA**



1510CX

**CONTRA FECHADURA 3530 V/V PARA 1510CX COM RECORTE P/ CADEIRINHA**



1511CX

**BATEDEIRA 3530 V/A PARA 1510CX COM RECORTE P/ CADEIRINHA**



1511ACX

**MINI FECHADURA PARA PORTA DE CORRER**



1510M

**MINI CONTRA FECHADURA V/V PARA PORTA DE CORRER**



1511MVV

**MINI BATEDEIRA V/A PARA PORTA DE CORRER**



1511MVA

**FECHADURA DE PRESSÃO ESQUERDA E DIREITA PARA PORTA DE CORRER**

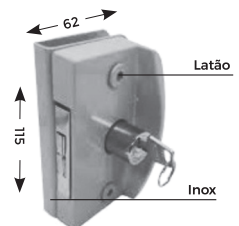

1510 XP

**CONTRA FECHADURA DE PRESSÃO 1510XP**

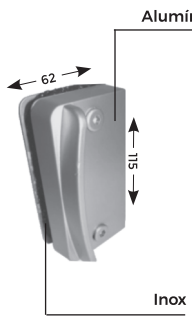

1511 XP

**FECHADURA PARA JANELA DE CORRER (SEM CILINDRO E PUXADOR EXTERNO)**

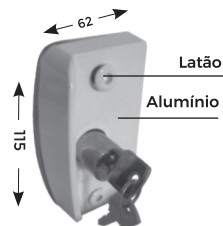

1510 XA

**CONTRA FECHADURA 3536 PARA JANELA DE CORRER**

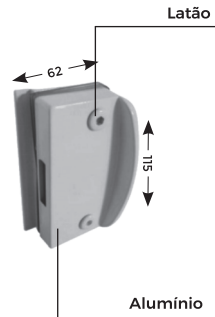

1511 XA

**FECHADURA DE CENTRO COM 2 CILINDROS**

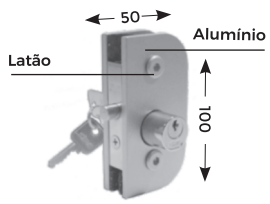

1520

**CONTRA FECHADURA COM ABA PARA 1520**

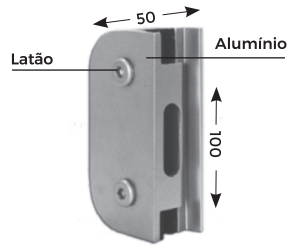

1504 A

**CONTRA FECHADURA SEM ABA PARA 1520**



1504

**BATEDEIRA EM ALVENARIA PARA 1520**

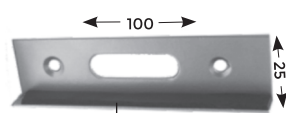

1504 B

**FECHADURA PARA PORTA DE ABRIR BATE E FECHA**



1520BF

FECHADURA DE CENTRO  
COM ROLETE

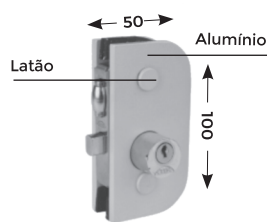

1520TR

CONTRA FECHADURA V/V  
COM ABA PARA 1520TR



1504ATR

BATEDEIRA V/A  
PARA 1520TR



1504BTR

FECHADURA PARA  
PORTA DE ABRIR



1520R

FECHADURA PARA  
PORTA DE ABRIR  
ROLETE/CEGO



1520R1

FECHADURA DE  
CENTRO COM CHAVE TETRA



1520T

FECHADURA DE CENTRO  
1 LADO

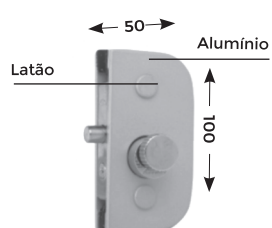

1520 RC

FECHADURA DE PRESSÃO

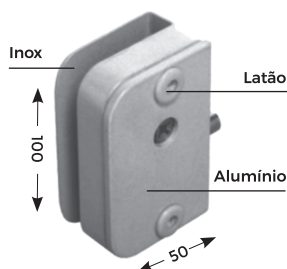

1520 P

CONTRA FECHADURA DE  
PRESSÃO PARA 1520 P

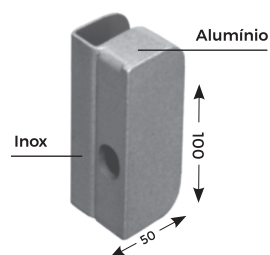

1504 P

FECHADURA DE CENTRO  
MODELO BLINDEX



1520X

CONTRA-FECHADURA  
PARA 1520X V/V SEM ABA



1504X

CONTRA-FECHADURA  
PARA 1520X V/V COM ABA



1504AX

FECHADURA DE CENTRO  
COM 2 CILINDROS  
SEM MAÇANETA

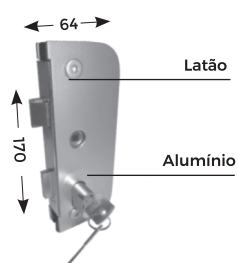

1520 MC

CONTRA FECHADURA PARA  
1520 MC

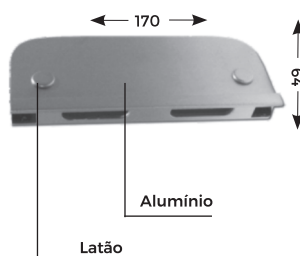

1504 MC

BATEDEIRA EM ALVENARIA  
PARA 1520 MC

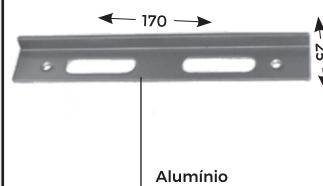

1504 AMC

MAÇANETA MODELO PADRÃO  
PARA 1520 MC



MAC01

MAÇANETA MODELO PADRÃO  
ALAVANCA PARA 1520MC



MAC02

MAÇANETA MODELO  
BOLA PARA 1520MC



MAC03

**DOBRADIÇA PIVOTANTE SUPERIOR COM PIVOT 1009 (AÇO INOX)**

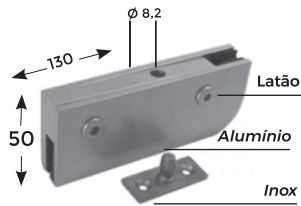

1101

**DOBRADIÇA PIVOTANTE SUPERIOR PARA 1203 E 1209**



1101A

**MINI DOBRADIÇA PIVOTANTE SUPERIOR COM PIVOT 1009 (AÇO INOX)**

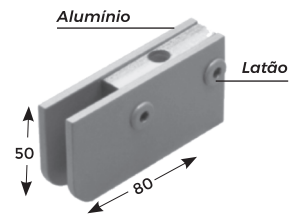

1101 M

**MAX DOBRADIÇA PIVOTANTE SUPERIOR COM PIVOT 1009 (AÇO INOX)**

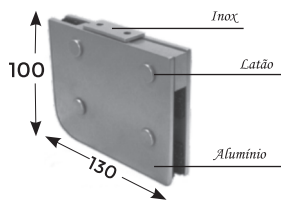

1101 G

**DOBRADIÇA PIVOTANTE INFERIOR COM PIVOT 1014 (AÇO INOX)**

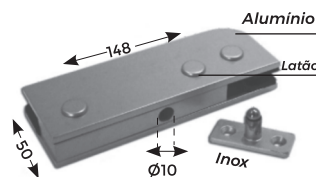

1102

**MINI DOBRADIÇA PIVOTANTE INFERIOR COM PIVOT 1014 (AÇO INOX)**

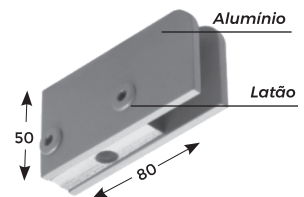

1102 M

**MAX DOBRADIÇA PIVOTANTE INFERIOR COM PIVOT 1014 (AÇO INOX)**

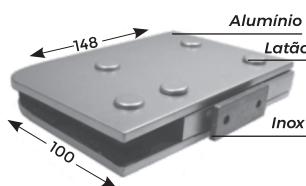

1102 G

**DOBRADIÇA INFERIOR**

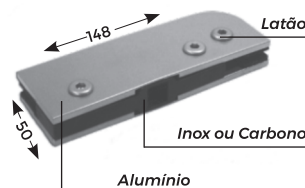

1103

**MAX DOBRADIÇA PIVOTANTE INFERIOR COM PIVOT PARA MOLA 1012**

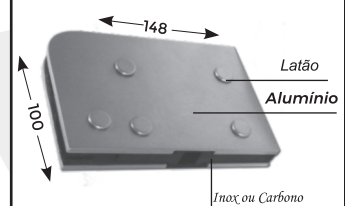

1103 G

**DOBRADIÇA AUTOMÁTICA  
PARA BOX**

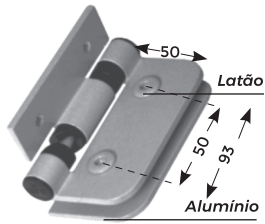

1114

**DOBRADIÇA AUTOMÁTICA  
DUPLA DIREITA/ESQUERDA**

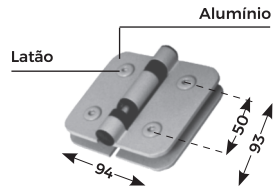

1114 D, 1114 E

**DOBRADIÇA INJETADA  
AUTOMÁTICA  
P/ BOX BI-PARTIDA**



1114A

**DOBRADIÇA (NÃO  
AUTOMÁTICA) PARA BOX**

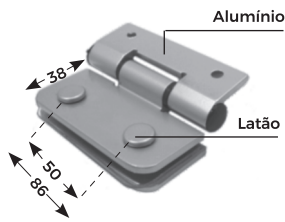

1115

**DOBRADIÇA INJETADA  
SIMPLES PARA  
BOX BI-PARTIDA**



1115A

**DOBRADIÇA  
(NÃO AUTOMÁTICA)  
DUPLA PARA BOX  
(SUBSTITUI 1114 D/E)**



1115D

**DOBRADIÇA PARA  
MAXIM-AR V/V  
(40mm ENTRE FUROS)**

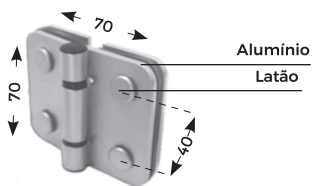

1131

**DOBRADIÇA PARA MAXIM-AR  
V/A (40mm ENTRE FUROS)**

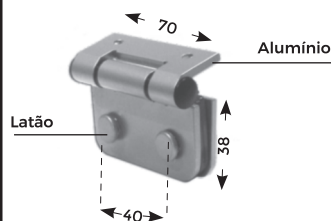

1132

**DOBRADIÇA PARA MAXIM-AR  
V/A (50mm ENTRE FUROS)**

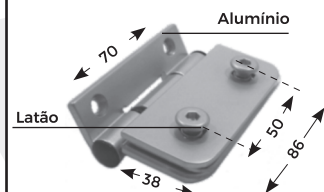

1133



**DOBRADIÇA PARA MAXIM-AR V/V (50mm ENTRE FUROS)**

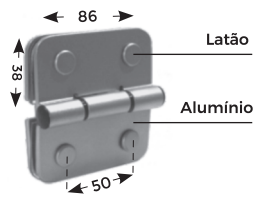

1134

**DOBRADIÇA SIMPLES PARA JANELA**

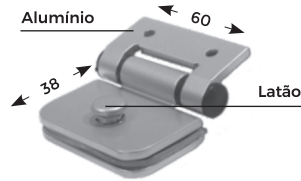

1136

**DOBRADIÇA DUPLA PARA JANELA**

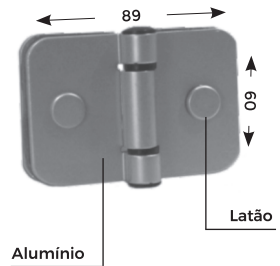

1137

**DOBRADIÇA PIVOTANTE DE PRESSÃO (6MM) RACK**



1141P

**DOBRADIÇA COM PINO PARA BASCULANTE 50x50**

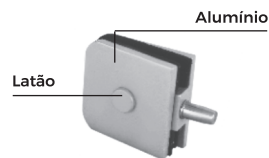

50X50

1123

**DOBRADIÇA PARA BASCULANTE 50x50**

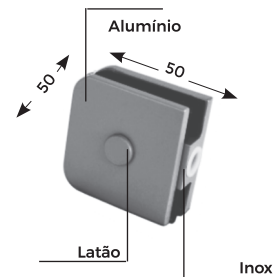

1230

**DOBRADIÇA LATERAL PARA PORTA DE GIRO**



1128A

**DOBRADIÇA COM PINO PARA BASCULANTE 50x100**

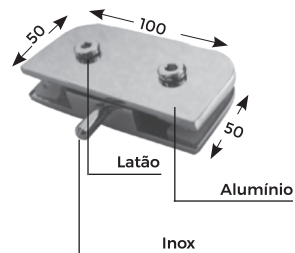

1130

**DOBRADIÇA PARA BASCULANTE 50x100**

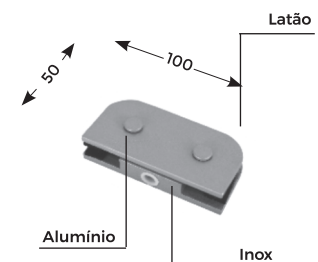

1231

**SUPOORTE DE CANTO**

Alumínio Latão

1302

**SUPOORTE CENTRAL SEM NÚCLEO**

Alumínio Latão

1305

**SUPOORTE PARA UNIÃO DE 2 VIDROS**

1306

**SUPOORTE PARA UNIÃO DE 3 VIDROS (SEM NÚCLEO)**

Alumínio Latão

1307

**SUPOORTE DE UNIÃO DE 3 VIDROS (COM NÚCLEO)**

1308

**SUPOORTE SEM NÚCLEO PARA UNIÃO DE 3 VIDROS**

Alumínio Latão

1310

**SUPER SEM NÚCLEO PARA UNIÃO DE 3 VIDROS COM BATEDEIRA**

Alumínio Latão

1315

**SUPOORTE SEM NÚCLEO PARA UNIÃO DE 4 VIDROS**

1316

**SUPOORTE CENTRAL PARA UNIÃO DE 4 VIDROS INSTALAÇÃO A 90°**

Alumínio Latão

90°

1319

**SUPORE CENTRAL  
COM ROSCA  
PARA 1150S (BOX)**



1332

**GRAPA PARA SACADAS  
50X60mm (SEM RECORTE)**



1334

**SUPORE DE CANTO  
COM ROSCA PARA  
ROLDANA 1150/1150S**



1340

**SUPORE DE CENTRO  
COM ROSCA PARA  
ROLDANA 1150/1150S**



1341

**BATEDEIRA DE PRESSÃO SEM  
NÚCLEO PARA BANDEIRA**

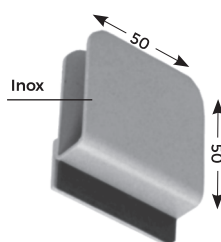

1402

**SUPORE DE BANDEIRA  
COM PINO (AÇO INOX) PARA  
DOBRADIÇA 1101 A**



1203

**FACÃO SIMPLES COM PINO  
(AÇO INOX) PARA BANDEIRA  
E FIXO**

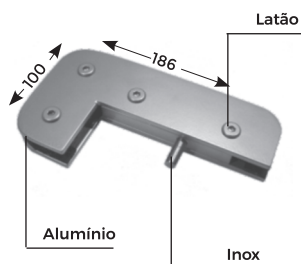

1209

**FACÃO DIREITO/ESQUERDO  
A 90° COM PINO (AÇO INOX)**



1209D, 1209E

**MAX FACÃO  
COM PINO (AÇO INOX)  
PARA BANDEIRA E FIXO**



1209G

**SUPORE CENTRAL PARA UNIÃO DE 2 VIDROS INSTALAÇÃO A 90°**

1320

**SUPORE PISO/TETO PARA UNIÃO DE 2 VIDROS A 90°**

1321

**SUPORE DE CENTRO PARA UNIÃO DE 2 VIDROS A 90°**

1322

**SUPORE PARA UNIÃO DE 2 VIDROS A 135°**

1322A

**SUPORE PARA UNIÃO DE 4 VIDROS PERPENDICULARES**

1323

**MINI SUPORTE PARA FIXAÇÃO**

1326

**SUPORE CENTRAL 50X50mm**

1329

**PORTA CADEADO**

1330

**SUPORE PARA PRATELEIRAS**

1333

**HASTE DE COMANDO PARA MAXIM-AR**

Alumínio  
Nylon

200 a 600mm

**Dimensões**

20cm	45cm
25cm	50cm
30cm	55cm
35cm	60cm
40cm	

1587

**SUPORE PARA HASTE V/V**

Alumínio  
Nylon

35  
50  
105  
Ø25

Alumínio

1587 VV

**SUPORE PARA HASTE V/A**

Alumínio  
Nylon

35  
50  
55  
Ø25

Alumínio

1587 VA

**BATEDEIRA SUPERIOR PARA PORTA SANFONADA**

1403

**CANTONEIRA COMPLETA V/A PARA SISTEMA "SÓ VIDRO" COM 1006**

1336

**CONJUNTO MÃO DE AMIGO PARA PORTAS DE CORRER**

Alumínio  
Latão

32  
32  
110

1710

**MINI CONJUNTO MÃO DE AMIGO PARA PORTAS DE CORRER**

Alumínio  
Latão

32  
32  
60

1710 M

ENGATE PARA CORRENTE  
EM ALVENARIA



1000

BOTÃO DE CORREÇÃO  
COM ENGATE  
PARA CORRENTE



1001

BOTÃO DE CORREÇÃO  
LÂMINA COM ENGATE  
PARA CORRENTE



1001L

BATEDEIRA PARA  
TRINCO BASCULANTE



1400

CORRENTE PARA TRINCO  
BASCULANTE (m)



1003

ARGOLA PARA BASCULANTE



1003 A

BOTÃO DE CORREÇÃO COM  
PARAFUSO

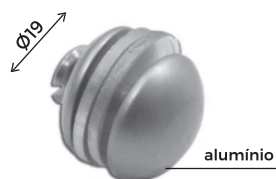

1002

BOTÃO DE CORREÇÃO  
COM LÂMINA



1002A

**PUXADOR DUPLO PARA BOX (MINI) Ø19,05mm**

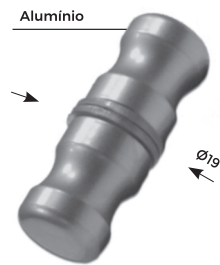

1629

**PUXADOR DUPLO PARA BOX (MAXI) Ø 20,40MM**



1630

**MINI PUXADOR PARA TRANPASSE EM PORTAS E JANELAS COM 1 FURO**

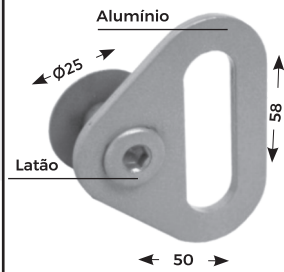

1671

**PUXADOR SIMPLES PARA JANELA (MINI) Ø19,05mm**

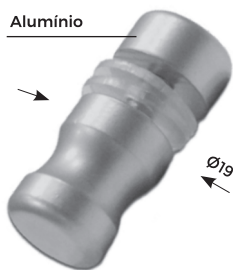

1650

**PUXADOR SIMPLES PARA JANELA (MAXI) Ø25,40mm**

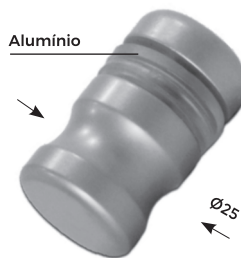

1651

**MINI PUXADOR DUPLO PARA TRANPASSE EM PORTAS E JANELA COM 1 FURO**

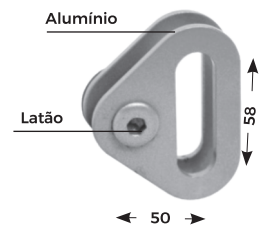

1671 MD

**PUXADOR QUADRADO 50X50MM**

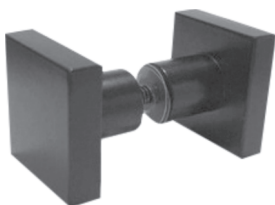

PUX040

**PUXADOR ABS BOTAO**



PUX050

**PUXADOR CONCHA EMBUTIR**



PUX060

**PUXADOR TUBULAR**  
CÓDIGO ENTRE-FUROS

300mm  
entre furos

450

Alumínio

1679-30  
1679-50  
1679-60  
1679-80

**PUXADOR BARRA CHATA INOX E CROMADO**  
CÓDIGO ENTRE-FUROS

1681-30    1681-80  
1681-40    1681-100  
1681-60    1681-120

**PUXADOR BARRA RETANGULAR EM INOX**

1681-RET-80  
1681-RET-100  
1681-RET-120

**PUXADOR TUBULAR**  
Ø25,4MM  
(300MM ENTRE FUROS)

1676

**PUXADOR SIMPLES COM BOTÃO DE ACABAMENTO**  
(300MM ENTRE FUROS)

1676S

**PUXADOR BARRA CHATA CURVADO DOIS FUROS**

W1681-35

**PUXADOR BARRA CHATA CURVADO UM FURO**

W1681-40



**CAPUCHINHO PARA TRINCO E FECHADURA**

Alumínio

1038

**PRESILHA PARA TRINCO 1521 A/1519**

Alumínio

1038 C

**TRINCO PARA JANELA E PORTA DE CORRER COM MOLA**

Inox

Alumínio

1521 A

**TRINCO PARA JANELA E PORTA COM FERROLHO PROLONGADO**

1521B

**TRINCO COM FERROLHO LATERAL**

1521L

**TRINCO CENTRAL PARA BASCULANTE**

Alumínio

1523

**CONTRA TRINCO V/V PARA 1521 A/1523**

Alumínio

1524

**CONTRA TRINCO C/ BATENTE PARA 1523**

1525

TRINCO INFERIOR SEM NÚCLEO 50X100mm

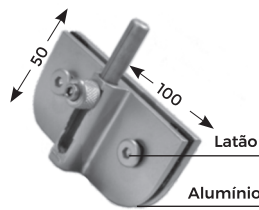

Inox  
1519

CONTRA TRINCO V/V SEM ABA PARA 1519

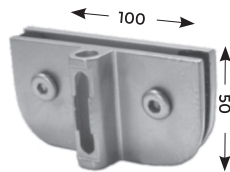

1532

CONTRA TRINCO V/V COM ABA PARA 1519

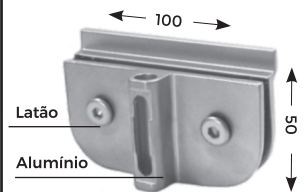

1532 A

FECHO/PUXADOR PARA JANELA DE CORRER V/V

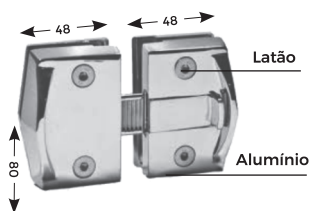

FECVV

FECHADOR/PUXADOR PARA JANELA DE CORRER V/A

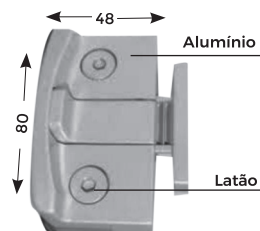

FECVA

FIXADOR DE PORTA RODAPÉ/PISO

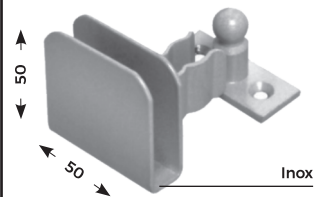

1702

FECHO/PUXADOR PARA JANELA DE CORRER V/V

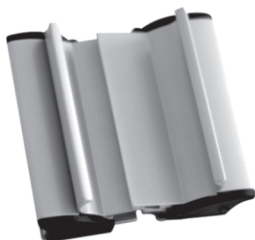

1570

FECHO/PUXADOR PARA JANELA DE CORRER V/A



1571

FECHO DE PRESSÃO PARA PORTAS DE EXTINTORES



1704

TRINCO PARA JANELA DE CORRER FRONTAL

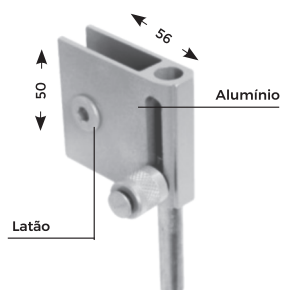

1800

TRINCO PARA JANELA DE CORRER LATERAL



1800A

TRINCO DE PRESSÃO PARA JANELA DE CORRER LATERAL



1800AS

TRINCO DE PRESSÃO LATERAL PARA JANELA DE CORRER

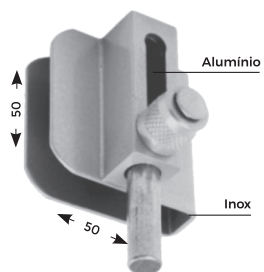

1800 B

TRINCO DE PRESSÃO SEM NÚCLEO

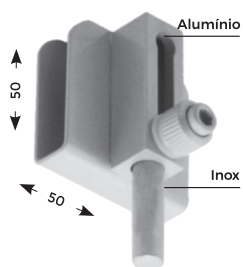

1800 C

CONTRA TRINCO DE PRESSÃO PARA 1800C



1529

TRINCO DE PRESSÃO PARA JANELA DE CORRER FRONTAL

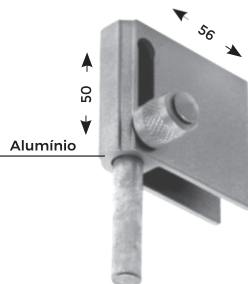

1800 S

TRINCO DIREITO PARA JANELA DE CORRER



1810D

TRINCO ESQUERDO PARA JANELA DE CORRER



1810E

TRINCO CENTRAL PARA  
JANELA DE CORRER  
COM TRANSPASSE



1813

MOLA HIDRÁULICA AÉREA



1012 SD

MOLA DE PISO  
DORMA



NÃO ACOMPANHA SUPORTES

BTS-60 DORMA  
BTS-4400 IMPORTADA

SUPORTE PARA MOLA AÉREA  
(BANDEIRA) (SEM RECORTE)



1906 B

SUPORTE PARA MOLA AÉREA  
(PORTA) (SEM RECORTE)

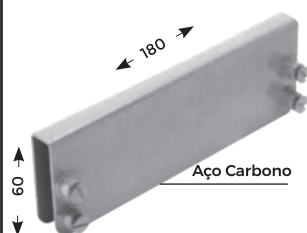

1906 P

CUNHA



VIDRO

CUN-001  
CUN-002

CALÇO FOLHA FIXA



CAL010

AMORTECEDOR  
CURVO DE BORRACHA



BAT002

LIMITADOR CENTRAL  
COM PARAFUSO T



BAT004

## KIT DE BOX FRONTAL



BTF 1200    BTF 1800  
BTF 1330    BTF 2000  
BTF 1500    BTF 2400

## KIT DE BOX CANTO



BTC 1.00 X 1.00  
BTC 1.10 X 1.10  
BTC 1.20 X 1.20

## KIT DE BOX FRONTAL ELEGANCE



BTF 1500 ELEGANCE  
BTF 2000 ELEGANCE

## KIT DE BOX DE CANTO ENCANTO



BTC2000 ENCANTO  
BTC2500 ENCANTO

## KIT DE BOX FRONTAL FLEX



BTFLEX

## PRIMER



LATA COM 940ML

## SILANO



EMBALAGEM COM 200ML

## SILICONE FIXA ESPELHO



FIXA ESPELHO

## SILICONE



ACÉTICO E NEUTRO

BRANCO  
INCOLOR  
PRETO

## SELANTE



PU

## CHAPA DE ALUMÍNIO

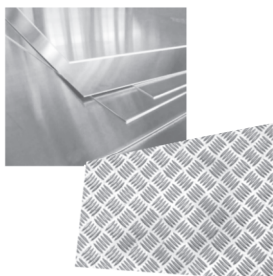

CHAPA L/X

CONSULTE MEDIDAS  
E ESPESSURAS

## CHAPA DE POLICARBONATO

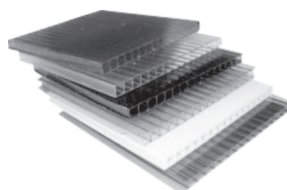

POLICARBONATO

## CHAPA DE ACM

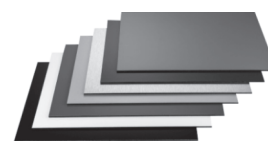

ACM

## CORTADOR DE VIDRO



VIDRO

CRT

## VENTOSA



VIDROS

VENTOSA

## FITA DUPLA FACE ROLO C/ 20M



FIA002 - 12MM  
FIA004 - 25MM P/ PVII

## PARAFUSOS



DIVERSOS

CONSULTE TIPOS  
E TAMANHOS

## SUPORE FENDA



ST060 - 6mm  
ST100 - 10mm

## TORRES INOX



TR030  
TR040  
TR060

## PROLONGADOR P/ VIDRO

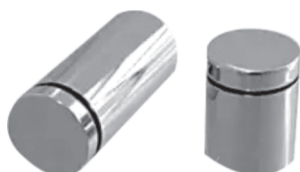

PROLONGADOR

1660 - 25x25  
1680 - 25x50

## BOTÃO FRANCÊS



BT091

## SUPORE TUCANO INOX



ST-090

GUARNIÇÃO CUNHA  
PARA VIDRO

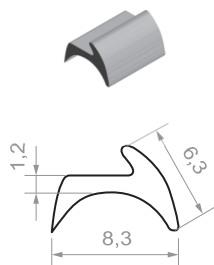

VIDROS 8MM  
GUA-038

GUARNIÇÃO CUNHA  
PARA VIDRO

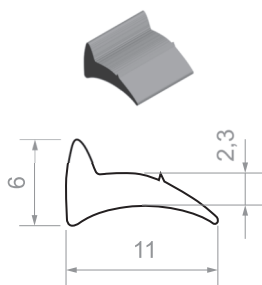

VIDROS 8MM  
GUA-038C

GUARNIÇÃO CUNHA  
PARA VIDRO

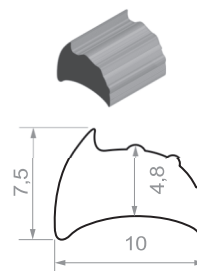

VIDROS 10MM  
GUA-039G

GUARNIÇÃO CUNHA  
PARA VIDRO

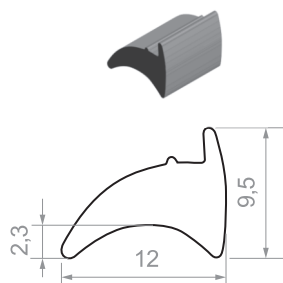

VIDROS 10MM  
GUA-051G

GUARNIÇÃO CUNHA  
PARA VIDRO

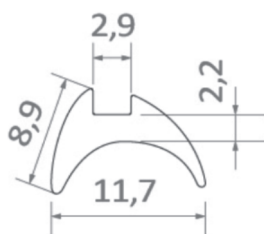

GUA-168

GUARNIÇÃO CUNHA  
PARA VIDRO

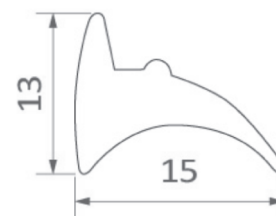

GUA-147

GUARNIÇÃO P/ TELA  
MOSQUITEIRA  
E INTEGRADA

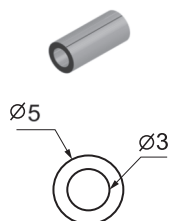

GUA-006

GUARNIÇÃO  
DO BATENTE

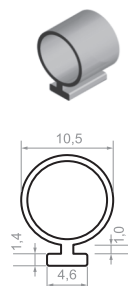

GUA-007

GUARNIÇÃO DA COLUNA  
E POLICARBONATO

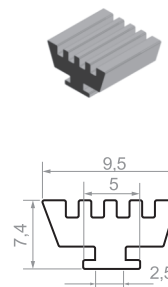

DIVERSOS  
GUA-030



## GUARNIÇÃO PARA COLUNA

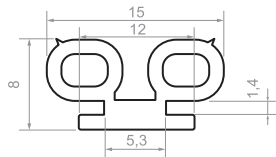
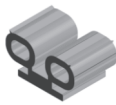

PELE DE VIDRO  
GUA-160

## GUARNIÇÃO EXTERNA PVII

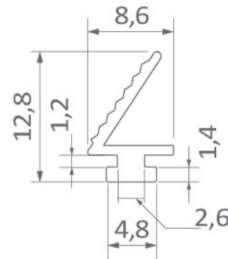

GUA-161

## GUARNIÇÃO INTERNA DA TRAVESSA DA COLUNA

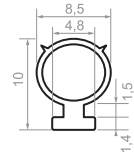
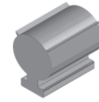

VIDROS 8MM  
GUA-162

## GUARNIÇÃO PARA MARCÓ FOLHA

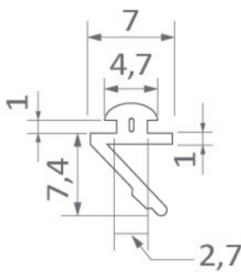

GUA-239

## GUARNIÇÃO TIPO CUNHA

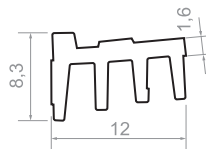
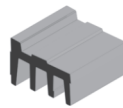

VIDRO 4MM a LIII  
GUA-256

## GUARNIÇÃO PARA LINHA BOX E SOROBOX



BOX DE ACRÍLICO

GUA-127 BOX  
GUA-128 SOROBOX

## FITAS VEDADORAS FELTRO

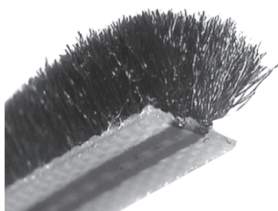

FITAS  
5X5 5X10  
5X6 7X6  
5X7 7X8  
5X8 7,5X6

## TARUGO FLEXÍVEL CINZA

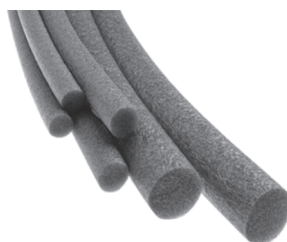

GUA-011 (10MM)  
GUA-013 (8MM)

## ESPONJA ADESIVA



GUA172 - 11 X 2 MM  
GUA258 - 11 X 4 MM  
GUA157 - 11 X 6 MM

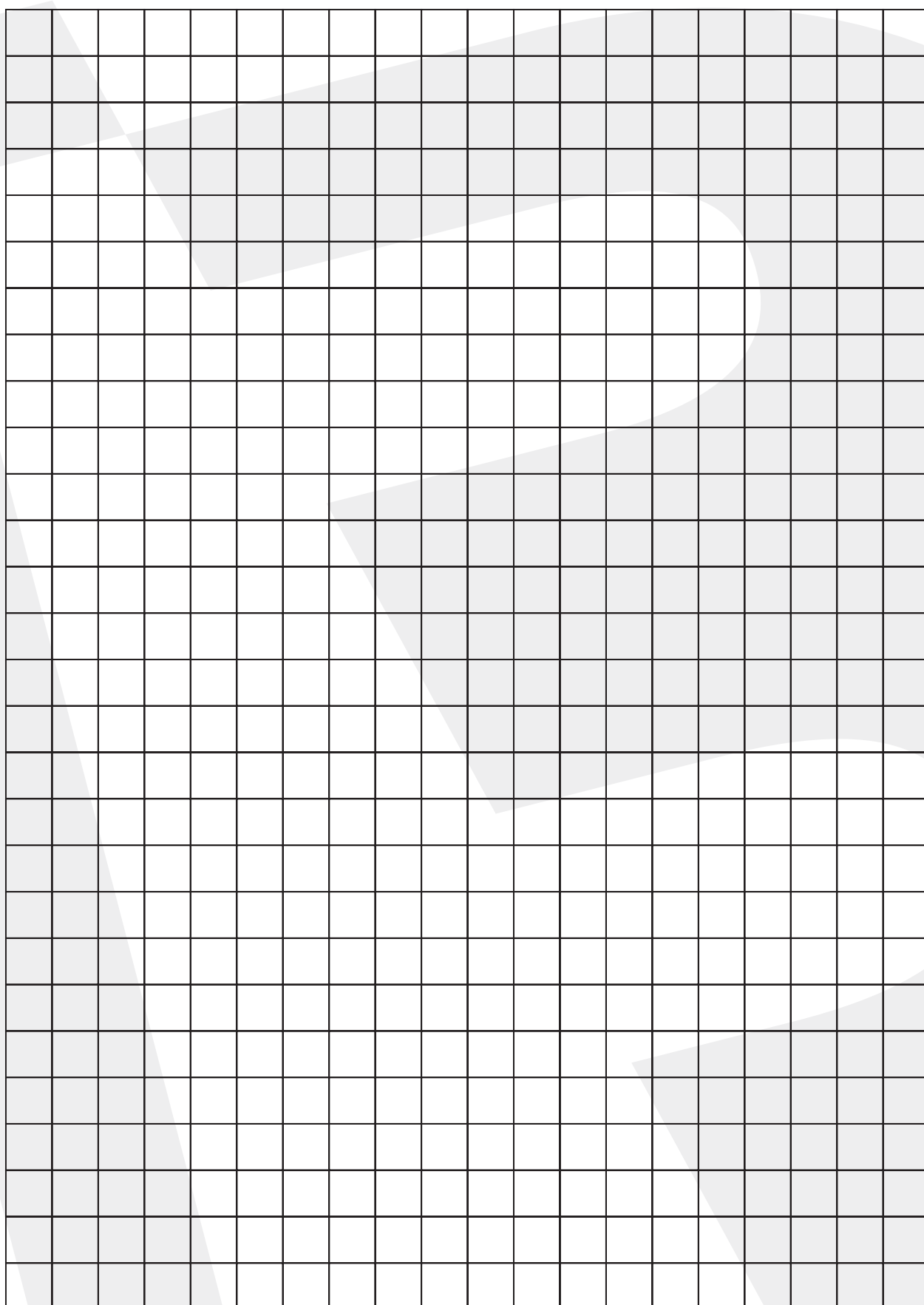

# **B** **BASSO** *alumínios*

✉ vendas@bassoaluminios.com.br

🌐 www.bassoaluminios.com.br

☎ (54) 3315-8900

Rua Dionísio Lângaro, 203  
São José - Passo Fundo

☎ (55) 3195-0727

Av. 21 de abril, 523 - Sala 02  
Centro - Ijuí

☎ (54) 3254-0298

Rua Miguel Vargas, 271  
Boqueirão - Passo Fundo

**Matriz Passo Fundo, Filial Ijuí e Passo Fundo - RS**

**Leia o QR CODE  
e baixe nosso catálogo em PDF**

